

Part No.501055100002

Rev: A

Jun 2020

# Operation Manual

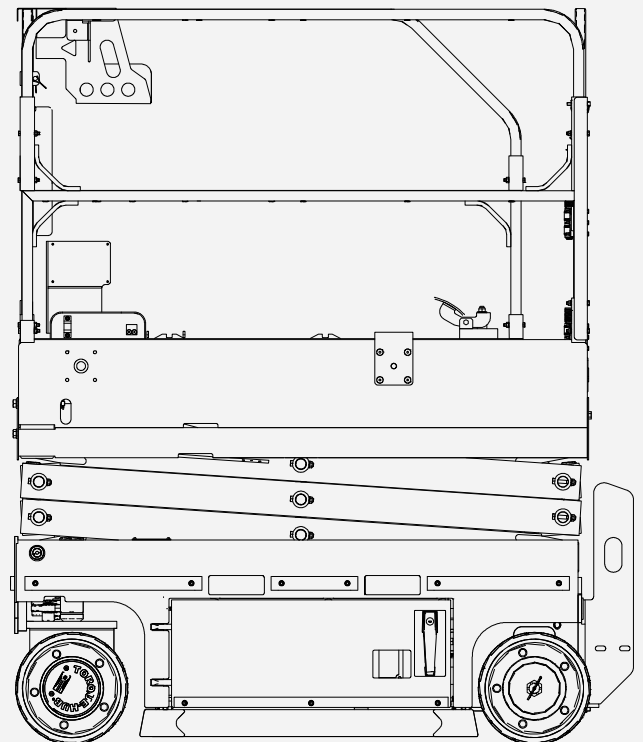
---

**GTJZ0408SE/0408SE/1530SE**

**GTJZ0608SE/0608SE/1930SE**

**GTJZ0408ME/0408ME/1532ME**

**GTJZ0608ME/0608ME/1932ME**



**CE** **ANSI** **AS/NZS** **SP** **EAC** **GB** **CCs**

**SINOBOOM**



 **WARNING**

**Operating, servicing and maintaining this vehicle or equipment can expose you to chemicals including engine exhaust, carbon monoxide, phthalates, and lead, which are known to the State of California to cause cancer and birth defects or other reproductive harm. To minimize exposure, avoid breathing exhaust, do not idle the engine except as necessary, service your vehicle or equipment in a well-ventilated area and wear gloves or wash your hands frequently when servicing. For more information go to: [www.P65warnings.ca.gov](http://www.P65warnings.ca.gov).**

## Manual revision history :

| REV | DATE      | DESCRIPTION                  | REMARK |
|-----|-----------|------------------------------|--------|
| A   | Jun, 2020 | Original issue of the manual |        |
|     |           |                              |        |
|     |           |                              |        |
|     |           |                              |        |
|     |           |                              |        |
|     |           |                              |        |
|     |           |                              |        |
|     |           |                              |        |
|     |           |                              |        |
|     |           |                              |        |
|     |           |                              |        |
|     |           |                              |        |
|     |           |                              |        |
|     |           |                              |        |
|     |           |                              |        |

### Please contact us:

Website : [www.sinoboom.com](http://www.sinoboom.com)

E-mail : [info@sinoboom.com](mailto:info@sinoboom.com)

Service Tel : 0086-400-608-1289

Sales Tel : 0086-400-601-5828

Fax : 0086-731-87116516-16

Address : No.128, East Jinzhou Avenue, Ningxiang High-tech Industrial Park, Changsha, Hunan, China

Zip Code : 410600

Copyright © Hunan Sinoboom Intelligent Equipment Co., Ltd. All Rights Reserved

The final interpretation right of this manual belongs to Hunan Sinoboom Intelligent Equipment Co., Ltd.

# APPLICATION

Use the following table to identify the specific serial number for models included in this manual. Check the model of your machine before consulting the manual, and then use the correct manual according to the serial number of the model. See the nameplate on your machine to identify the model and serial number. (See *10 Decals/Nameplates Inspection, page 10-1* of the *Operation Manual* for details.)

| MODELS     | Trade identification |          | SERIAL NO.                 |
|------------|----------------------|----------|----------------------------|
|            | Metric               | Imperial |                            |
| GTJZ0408SE | GTJZ0408SE           | 1530SE   | From 0105700104 to Present |
| GTJZ0608SE | GTJZ0608SE           | 1930SE   | From 0105800218 to Present |
| GTJZ0408ME | GTJZ0408ME           | 1532ME   | From 0105500104 to Present |
| GTJZ0608ME | GTJZ0608ME           | 0932ME   | From 0105600104 to Present |

## NOTE:

- Product model is applied in product nameplate for distinction of products of different main parameters.
- Product trade identification is applied in marketing and machine decals for distinction of products of different main parameters, and can be classified as metric type and imperial type: The metric type of trade identification is applicable to machines for countries/regions using metric system or as specially required by customers; The imperial type of trade identification is applicable to the machines for countries/regions using imperial system or as specially required by customers.

**This Page Intentionally Left Blank**

# STATEMENTS

Hunan Sinoboom Intelligent Equipment Co., Ltd. (Hereinafter referred to as Sinoboom) will upload the latest product manual information to the website [www.sinoboom.com](http://www.sinoboom.com) as soon as possible. However, due to continuous product improvement, the information in this manual is subject to change without prior notice.

This manual covers the basic parts information of one or more products. Therefore, please use this manual according to your needs. If you find problems in the manual or have suggestions for improvement, feel free to share your feedback with Sinoboom, and we will address these issues as soon as possible.

Feel free to consult and download the *Operation Manual*, *Maintenance Manual* and *Parts Manual* of the products you need online at [www.sinoboom.com](http://www.sinoboom.com).

Hunan Sinoboom Intelligent Equipment Co., Ltd. retains the right of final interpretation of the manual.

**This Page Intentionally Left Blank**



# TABLE OF CONTENTS

|  |            |   |            |
|--|------------|---|------------|
| <b>Introduction</b> .....                            | <b>iii</b> | Preparing for a Pre-operation Function Test ..... | 6-1        |
| <b>1 Performance Parameters</b> .....                | <b>1-1</b> | Testing the Ground Controller .....               | 6-1        |
| <b>2 Machine Components</b> .....                    | <b>2-1</b> | Testing the Ground Controller Function .....      | 6-2        |
| <b>3 Safety</b> .....                                | <b>3-1</b> | Testing the Emergency Stop Function .....         | 6-2        |
| Safety Definitions .....                             | 3-1        | Testing the Lifting and Lowering Functions .....  | 6-2        |
| Reporting Accidents .....                            | 3-1        | Testing the Platform Controller .....             | 6-2        |
| Electrocution Hazards .....                          | 3-1        | Testing the Platform Controller .....             | 6-3        |
| Tipping Hazards and Rated Load .....                 | 3-2        | Testing the Emergency Stop Function .....         | 6-3        |
| Work Environment Hazards .....                       | 3-4        | Testing the Horn .....                            | 6-3        |
| Unsafe Operation Hazards .....                       | 3-5        | Testing the Enabling Key Function .....           | 6-3        |
| Fall Hazards .....                                   | 3-6        | Testing the Lifting and Lowering Functions .....  | 6-4        |
| Collision Hazards .....                              | 3-7        | Testing the Steering Function .....               | 6-4        |
| Crush Hazards .....                                  | 3-8        | Testing the Driving and Braking Functions .....   | 6-4        |
| Explosion and Fire Hazards .....                     | 3-8        | Testing the Drive Speed .....                     | 6-4        |
| Damaged Machine Hazards .....                        | 3-8        | Testing the Emergency Lowering Function .....     | 6-5        |
| Bodily Injury Hazards .....                          | 3-8        | Testing the Tilt Protection Function .....        | 6-5        |
| Battery Hazards .....                                | 3-9        | Testing the Pothole Guard .....                   | 6-6        |
| Charging the Battery .....                           | 3-9        | Testing the Weighing System (optional) .....      | 6-6        |
| Handling the Battery .....                           | 3-9        | <b>7 Operating the machine</b> .....              | <b>7-1</b> |
| Welding and Polishing Requirements .....             | 3-9        | Using the Emergency Stop Function .....           | 7-1        |
| After Using the Machine .....                        | 3-10       | Using the Emergency Lowering Feature .....        | 7-1        |
| <b>4 Jobsite Inspection</b> .....                    | <b>4-1</b> | Using the Emergency Pull/Drag Feature .....       | 7-1        |
| <b>5 Pre-operation Inspection</b> .....              | <b>5-1</b> | Operating on the Ground .....                     | 7-2        |
| Tips for Conducting a Pre-operation Inspection ..... | 5-1        | Operating on the Platform .....                   | 7-2        |
| Conducting a Pre-operation Inspection .....          | 5-1        |   |            |
| Inspecting Parts .....                               | 5-2        |   |            |
| Inspecting Entire Machine .....                      | 5-2        |   |            |
| Inspect Hydraulic Oil Level .....                    | 5-2        |   |            |
| Inspecting the Battery .....                         | 5-2        |   |            |
| <b>6 Pre-operation Function Test</b> ..              | <b>6-1</b> |   |            |

|  |             |
|--|-------------|
| Operating with the Platform Controller on the Ground .....       | 7-4         |
| Driving on a Slope.....  | 7-4         |
| Using the Battery Level Indicator .....                          | 7-4         |
| Charging the Battery .....                                       | 7-5         |
| Changing Charger Battery Curve .....                             | 7-6         |
| <b>8 Transporting and Lifting the Machine .....</b>              | <b>8-1</b>  |
| Lifting the Machine with a Forklift .....                        | 8-1         |
| Lifting the Machine with a Crane .....                           | 8-2         |
| Transporting the Machine .....                                   | 8-2         |
| <b>9 Maintenance .....</b>                                       | <b>9-1</b>  |
| Conducting a Pre-delivery Inspection .                           | 9-1         |
| Following a Maintenance Schedule ...                             | 9-2         |
| Completing a Repair & Inspection Report.....                     | 9-2         |
| <b>10 Decals/Nameplates Inspection .....</b>                     | <b>10-1</b> |
| GTJZ0408SE&0608SE&0408-ME&0608ME Decals/Nameplates (CE).....     | 10-2        |
| GTJZ0408SE&0608SE&0408-ME&0608ME Decals/Nameplates (AS).....     | 10-5        |
| GTJZ0408SE&0608SE&0408-ME&0608ME Decals/Nameplates (KCS).....    | 10-8        |
| GTJZ0408SE&0608SE&0408-ME&0608ME Decals/Nameplates (CE-PL) ..... | 10-11       |
| GTJZ0408SE&0608SE&0408-ME&0608ME Decals/Nameplates (JP) .....    | 10-14       |
| GTJZ0408SE&0608SE&0408-ME&0608ME Decals/Nameplates (ANSI) .....  | 10-17       |

|  |            |
|--|------------|
| <b>Appendix 1: Symbols and Description.....</b>                  | <b>A-1</b> |
| <b>Appendix 2: Prepare the Work Record Before Delivery .....</b> | <b>A-5</b> |
| <b>Appendix 3: Repair &amp; Inspection Report .....</b>          | <b>A-7</b> |

# INTRODUCTION

Thank you for choosing and using the machinery of Hunan Sinoboom Intelligent Equipment Co., Ltd. Always read, understand and become familiar with the operation requirements of the machine and its associated safety procedures before operating, maintaining and repairing the machine. Operating the machine without becoming familiar with its specific operation requirements and safety procedures poses serious risks. Operators who follow safety rules and operate the machine carefully and effectively will prevent personal injury, property loss and accidents.

Use this machine only to transport tools to work locations and for performing tasks on the work platform. Operators must be competent and must obtain training to carefully use the machine and follow safety procedures. Only trained and authorized personnel may operate the machine.

This manual guides the operator in operating and using the machine. The operator is responsible for reading, understanding and implementing the operation and safety procedures in this manual and for following the manufacturer's instructions before beginning any work. Read, understand and follow all safety rules and operating instructions. The operator must also consider the machine's uses and limitations and the conditions at the jobsite before using this machine. Strictly following all safety requirements in this manual is critical.

Consider this manual a part of the machine, along with *Maintenance Manual* and *Parts Manual*, and always keep the manuals with the machine. The owner or administrator of the machine shall offer all manuals and other necessary information provided by the machine manufacturer regarding the daily inspection and maintenance to each of the renters. If the machine is sold, the owner or administrator must pass along the manuals and other necessary information to the purchaser. The owner or administrator of the machine shall also provide the manufacturer's maintenance information to the person responsible for maintaining the machine.

If you have any questions, contact Hunan Sinoboom Intelligent Equipment Co., Ltd..

**This Page Intentionally Left Blank**

# 1 PERFORMANCE PARAMETERS

Table 1-1 GTJZ0408SE Specifications

| MEASURE                                      | GTJZ0408SE (METRIC)                   | 1530SE (IMPERIAL)         |
|--|---------------------------------------|---------------------------|
| <b>DIMENSION PARAMETERS</b>                  |                                       |                           |
| Max. platform height                         | 4.6m                                  | 15ft 1in                  |
| Max. working height                          | 6.6m                                  | 21ft 8in                  |
| Max. horizontal extension                    | 0.9m                                  | 3ft                       |
| Length                                       | 1.8m                                  | 5ft 11in                  |
| Width  | 0.79m                                 | 2ft 7in                   |
| Height (stowed, rails folded)                | 1.87m                                 | 6ft 2in                   |
| Height (stowed, rails up)                    | 2.12m                                 | 6ft 11.5in                |
| Wheel base                                   | 1.334m                                | 4ft 4in                   |
| Wheel span                                   | 0.66m                                 | 2ft 2in                   |
| Ground clearance (pothole guards retracted)  | 0.075mm                               | 3in                       |
| Ground clearance (pothole guards deployed)   | 24mm                                  | 0.95in                    |
| Tire size (diameter × width / type)          | Φ323×100mm/Solid                      | Φ12.7×4 in/Solid          |
| Platform dimension (Length × Width × height) | 1.64×0.76×1.1m                        | 5ft 4.6in×2ft 6in×3ft 7in |
| <b>PERFORMANCE PARAMETERS</b>                |                                       |                           |
| Rated load capacity of platform              | 280kg                                 | 617 lb                    |
| Max. load capability of extended platform    | 120kg                                 | 265 lb                    |
| Max. platform occupancy(indoor only)         | 2 person                              |                           |
| Drive speed (stowed)                         | 0 ~ 4km/h                             | 0 ~ 2.5 mph               |
| Drive speed (raised)                         | 0 ~ 0.8km/h                           | 0 ~ 0.5 mph               |
| Uptime (in a no-load state)                  | 15 ~ 20s                              |                           |
| Downtime (in a no-load state)                | 28 ~ 33s                              |                           |
| Gradeability                                 | 25%                                   |                           |
| Max. allowable inclination                   | 3°(Front to back)/1.5°(Left to right) |                           |
| Turning radius (inside)                      | 0m                                    | 0ft                       |
| Turning radius (outside)                     | 1.49m                                 | 4ft 10.7in                |
| Rated load capacity of a single tire         | 550kg                                 | 1212.5 lb                 |

Table 1-1 GTJZ0408SE Specifications (continued)

| MEASURE  | GTJZ0408SE (METRIC)   | 1530SE (IMPERIAL)             |
|--|---|-------------------------------|
| Max. allowable manual force (indoor only)            | 400N  | 90 lbf                        |
| Max. noise   | 72dB  |                               |
| <b>POWER PARAMETERS</b>                              |   |                               |
| Hydraulic tank capacity                              | 6L  | 1.3 gal(imperial)/1.6 gal(US) |
| Hydraulic system capacity (including tank)           | 7L  | 1.5 gal(imperial)/1.8 gal(US) |
| Hydraulic system pressure                            | 21MPa   | 3046 Psi                      |
| Battery specification (quantity × voltage, capacity) | 4×6V,225Ah  |                               |
| System voltage                                       | 24VDC   |                               |
| Control voltage                                      | 24VDC   |                               |
| <b>ENVIRONMENTAL REQUIREMENT</b>                     |   |                               |
| Max. allowable wind speed (indoor only)              | 0m/s  | 0mph                          |
| Max. allowable altitude                              | 3000m   | 9843ft                        |
| Allowable ambient temperature (lead-acid batteries)  | -10°C to 40°C   | 14°F to 104°F                 |
| Allowable ambient temperature (lithium batteries)    | -20°C to 40°C   | -4°F to 104°F                 |
| Max. allowable ambient relative humidity             | 90%   |                               |
| Storage condition                                    | Stored at -20°C to 50°C(-4°F to 122°F) in a well-ventilated environment with 90% relative humidity (20°C [68°F]), and away from rain, sun, corrosive gas and inflammable explosive. |                               |
| <b>WEIGHT</b>  |   |                               |
| Weight (in a no-load state) (indoor only)            | 1375kg  | 3032 lb                       |

Table 1-2 GTJZ0608SE Specifications

| MEASURE                       | GTJZ0608SE (METRIC) | 1930SE (IMPERIAL) |
|-------------------------------|---------------------|-------------------|
| <b>DIMENSION PARAMETERS</b>   |                     |                   |
| Max. platform height          | 5.8m                | 19ft              |
| Max. working height           | 7.8m                | 25ft 7in          |
| Max. horizontal extension     | 0.9m                | 3ft               |
| Length                        | 1.8m                | 5ft 11in          |
| Width                         | 0.79m               | 2ft 7in           |
| Height (stowed, rails folded) | 1.88m               | 6ft 2in           |
| Height (stowed, rails up)     | 2.14m               | 7ft               |
| Wheel base                    | 1.334m              | 4ft 4in           |

**Table 1-2 GTJZ0608SE Specifications (continued)**

| MEASURE  | GTJZ0608SE (METRIC)                   | 1930SE (IMPERIAL)             |
|--|---------------------------------------|-------------------------------|
| Wheel span   | 0.66m                                 | 2ft 2in                       |
| Ground clearance (pothole guards retracted)          | 0.075mm                               | 3in                           |
| Ground clearance (pothole guards deployed)           | 24mm                                  | 0.95in                        |
| Tire size (diameter × width / type)                  | Φ323×100mm/Solid                      | Φ12.7×4 in/Solid              |
| Platform dimension (Length × Width × height)         | 1.64×0.76×1.1m                        | 5ft 4.6in×2ft 6in×3ft 7in     |
| PERFORMANCE PARAMETERS                               |                                       |                               |
| Rated load capacity of platform                      | 230kg                                 | 507 lb                        |
| Max. load capability of extended platform            | 120kg                                 | 265 lb                        |
| Max. platform occupancy(indoor only)                 | 2 person                              |                               |
| Drive speed (stowed)                                 | 0 ~ 4km/h                             | 0 ~ 2.5 mph                   |
| Drive speed (raised)                                 | 0 ~ 0.8km/h                           | 0 ~ 0.5 mph                   |
| Uptime (in a no-load state)                          | 15 ~ 20s                              |                               |
| Downtime (in a no-load state)                        | 25 ~ 30s                              |                               |
| Gradeability   | 25%                                   |                               |
| Max. allowable inclination                           | 3°(Front to back)/1.5°(Left to right) |                               |
| Turning radius (inside)                              | 0m                                    | 0ft                           |
| Turning radius (outside)                             | 1.49m                                 | 4ft 10.7in                    |
| Rated load capacity of a single tire                 | 550kg                                 | 1212.5 lb                     |
| Max. allowable manual force (indoor only)            | 400N                                  | 90 lbf                        |
| Max. noise   | 72dB                                  |                               |
| POWER PARAMETERS                                     |                                       |                               |
| Hydraulic tank capacity                              | 6L                                    | 1.3 gal(imperial)/1.6 gal(US) |
| Hydraulic system capacity (including tank)           | 7L                                    | 1.5 gal(imperial)/1.8 gal(US) |
| Hydraulic system pressure                            | 21MPa                                 | 3046 Psi                      |
| Battery specification (quantity × voltage, capacity) | 4×6V,225Ah                            |                               |
| System voltage                                       | 24VDC                                 |                               |
| Control voltage                                      | 24VDC                                 |                               |
| ENVIRONMENTAL REQUIREMENT                            |                                       |                               |
| Max. allowable wind speed (indoor only)              | 0m/s                                  | 0mph                          |
| Max. allowable altitude                              | 3000m                                 | 9843ft                        |

Table 1-2 GTJZ0608SE Specifications (continued)

| MEASURE   | GTJZ0608SE (METRIC)   | 1930SE (IMPERIAL) |
|---|---|-------------------|
| Allowable ambient temperature (lead-acid batteries) | -10°C to 40°C   | 14°F to 104°F     |
| Allowable ambient temperature (lithium batteries)   | -20°C to 40°C   | -4°F to 104°F     |
| Max. allowable ambient relative humidity            | 90%   |                   |
| Storage condition                                   | Stored at -20°C to 50°C(-4°F to 122°F) in a well-ventilated environment with 90% relative humidity (20°C [68°F]), and away from rain, sun, corrosive gas and inflammable explosive. |                   |
| WEIGHT  |   |                   |
| Weight (in a no-load state) (indoor only)           | 1575kg  | 3473 lb           |

Table 1-3 GTJZ0408ME Specifications

| MEASURE                                      | GTJZ0408ME (METRIC)                | 1532SE (IMPERIAL)         |
|--|------------------------------------|---------------------------|
| DIMENSION PARAMETERS                         |                                    |                           |
| Max. platform height                         | 4.6m                               | 15ft 1in                  |
| Max. working height                          | 6.6m                               | 21ft 8in                  |
| Max. horizontal extension                    | 0.9m                               | 3ft                       |
| Length                                       | 1.8m                               | 5ft 11in                  |
| Width  | 0.81m                              | 2ft 8in                   |
| Height (stowed, rails folded)                | 1.87m                              | 6ft 2in                   |
| Height (stowed, rails up)                    | 2.12m                              | 6ft 11.5 in               |
| Wheel base                                   | 1.334m                             | 4ft 4in                   |
| Wheel span                                   | 0.71m                              | 2ft 4in                   |
| Ground clearance (pothole guards retracted)  | 0.075mm                            | 3in                       |
| Ground clearance (pothole guards deployed)   | 24mm                               | 0.95in                    |
| Tire size (diameter × width / type)          | Φ323×100mm/Solid                   | Φ12.7×4 in/Solid          |
| Platform dimension (Length × Width × height) | 1.64×0.76×1.1m                     | 5ft 4.6in×2ft 6in×3ft 7in |
| PERFORMANCE PARAMETERS                       |                                    |                           |
| Rated load capacity of platform              | 280kg                              | 617 lb                    |
| Max. load capability of extended platform    | 120kg                              | 265 lb                    |
| Max. platform occupancy (indoor/outdoor)     | 2 person(indoor)/1 person(outdoor) |                           |
| Drive speed (stowed)                         | 0 ~ 4km/h                          | 0 ~ 2.5 mph               |
| Drive speed (raised)                         | 0 ~ 0.8km/h                        | 0 ~ 0.5 mph               |



**Table 1-3 GTJZ0408ME Specifications (continued)**

| MEASURE   | GTJZ0408ME (METRIC)   | 1532SE (IMPERIAL)              |
|---|---|--------------------------------|
| Uptime (in a no-load state)                             | 15 ~ 20s  |                                |
| Downtime (in a no-load state)                           | 28 ~ 33s  |                                |
| Gradeability  | 25%   |                                |
| Max. allowable inclination                              | 3°(Front to back)/1.5°(Left to right)   |                                |
| Turning radius (inside)                                 | 0m  | 0ft                            |
| Turning radius (outside)                                | 1.49m   | 4ft 10.7in                     |
| Rated load capacity of a single tire                    | 550kg   | 1212.5 lb                      |
| Max. allowable manual force (indoor/<br>outdoor)        | 400N(indoor)/200N(outdoor)  | 90 lbf(indoor)/45 lbf(outdoor) |
| Max. noise  | 72dB  |                                |
| POWER PARAMETERS  |   |                                |
| Hydraulic tank capacity                                 | 6L  | 1.3 gal(imperial)/1.6 gal(US)  |
| Hydraulic system capacity (including tank)              | 7L  | 1.5 gal(imperial)/1.8 gal(US)  |
| Hydraulic system pressure                               | 21MPa   | 3046 Psi                       |
| Battery specification (quantity × voltage,<br>capacity) | 4×6V,225Ah  |                                |
| System voltage  | 24VDC   |                                |
| Control voltage   | 24VDC   |                                |
| ENVIRONMENTAL REQUIREMENT                               |   |                                |
| Max. allowable wind speed (indoor/<br>outdoor)          | 0m/s(indoor)/12.5m/s(outdoor)   | 0 mph(indoor)/28 mph(outdoor)  |
| Max. allowable altitude                                 | 3000m   | 9843ft                         |
| Allowable ambient temperature (lead-acid<br>batteries)  | -10°C to 40°C   | 14°F to 104°F                  |
| Allowable ambient temperature (lithium<br>batteries)    | -20°C to 40°C   | -4°F to 104°F                  |
| Max. allowable ambient relative humidity                | 90%   |                                |
| Storage condition                                       | Stored at -20°C to 50°C(-4°F to 122°F) in a well-ventilated environment with 90% relative humidity (20°C [68°F]), and away from rain, sun, corrosive gas and inflammable explosive. |                                |
| WEIGHT  |   |                                |
| Weight (in a no-load state) (indoor/<br>outdoor)        | 1375kg  | 3032 lb                        |

Table 1-4 GTJZ0608ME Specifications

| MEASURE                                       | GTJZ0608ME (METRIC)                   | 1932ME (IMPERIAL)              |
|---|---------------------------------------|--------------------------------|
| <b>DIMENSION PARAMETERS</b>                   |                                       |                                |
| Max. platform height                          | 5.8m                                  | 19ft                           |
| Max. working height                           | 7.8m                                  | 25ft 7in                       |
| Max. horizontal extension                     | 0.9m                                  | 3ft                            |
| Length  | 1.8m                                  | 5ft 11in                       |
| Width   | 0.81m                                 | 2ft 8in                        |
| Height (stowed, rails folded)                 | 1.88m                                 | 6ft 2in                        |
| Height (stowed, rails up)                     | 2.14m                                 | 7ft                            |
| Wheel base                                    | 1.334m                                | 4ft 4in                        |
| Wheel span                                    | 0.71m                                 | 2ft 4in                        |
| Ground clearance (pothole guards retracted)   | 0.075mm                               | 3in                            |
| Ground clearance (pothole guards deployed)    | 24mm                                  | 0.95in                         |
| Tire size (diameter × width / type)           | Φ323×100mm/Solid                      | Φ12.7×4 in/Solid               |
| Platform dimension (Length × Width × height)  | 1.64×0.76×1.1m                        | 5ft 4.6in×2ft 6in×3ft 7in      |
| <b>PERFORMANCE PARAMETERS</b>                 |                                       |                                |
| Rated load capacity of platform               | 230kg                                 | 507 lb                         |
| Max. load capability of extended platform     | 120kg                                 | 265 lb                         |
| Max. platform occupancy (indoor/outdoor)      | 2 person(indoor)/1 person(outdoor)    |                                |
| Drive speed (stowed)                          | 0 ~ 4km/h                             | 0 ~ 2.5 mph                    |
| Drive speed (raised)                          | 0 ~ 0.8km/h                           | 0 ~ 0.5 mph                    |
| Uptime (in a no-load state)                   | 15 ~ 20s                              |                                |
| Downtime (in a no-load state)                 | 25 ~ 30s                              |                                |
| Gradeability                                  | 25%                                   |                                |
| Max. allowable inclination                    | 3°(Front to back)/1.5°(Left to right) |                                |
| Turning radius (inside)                       | 0m                                    | 0ft                            |
| Turning radius (outside)                      | 1.49m                                 | 4ft 10.7in                     |
| Rated load capacity of a single tire          | 550kg                                 | 1212.5 lb                      |
| Max. allowable manual force (indoor/ outdoor) | 400N(indoor)/200N(outdoor)            | 90 lbf(indoor)/45 lbf(outdoor) |
| Max. noise                                    | 72dB                                  |                                |
| <b>POWER PARAMETERS</b>                       |                                       |                                |

**Table 1-4 GTJZ0608ME Specifications (continued)**

| MEASURE  | GTJZ0608ME (METRIC)   | 1932ME (IMPERIAL)             |
|--|---|-------------------------------|
| Hydraulic tank capacity                              | 6L  | 1.3 gal(imperial)/1.6 gal(US) |
| Hydraulic system capacity (including tank)           | 7L  | 1.5 gal(imperial)/1.8 gal(US) |
| Hydraulic system pressure                            | 21MPa   | 3046 Psi                      |
| Battery specification (quantity × voltage, capacity) | 4×6V,225Ah  |                               |
| System voltage                                       | 24VDC   |                               |
| Control voltage                                      | 24VDC   |                               |
| ENVIRONMENTAL REQUIREMENT                            |   |                               |
| Max. allowable wind speed (indoor/ outdoor)          | 0m/s(indoor)/12.5m/s(outdoor)   | 0 mph(indoor)/28 mph(outdoor) |
| Max. allowable altitude                              | 3000m   | 9843ft                        |
| Allowable ambient temperature (lead-acid batteries)  | -10°C to 40°C   | 14°F to 104°F                 |
| Allowable ambient temperature (lithium batteries)    | -20°C to 40°C   | -4°F to 104°F                 |
| Max. allowable ambient relative humidity             | 90%   |                               |
| Storage condition                                    | Stored at -20°C to 50°C(-4°F to 122°F) in a well-ventilated environment with 90% relative humidity (20°C [68°F]), and away from rain, sun, corrosive gas and inflammable explosive. |                               |
| WEIGHT   |   |                               |
| Weight (in a no-load state) (indoor/ outdoor)        | 1575kg  | 3473lb                        |

**NOTE:**

- a) The working height adds 2m (6ft 7in) of human height to platform height.
- b) In different areas, hydraulic oil, engine oil, coolant, fuel and lubrication should be added in accordance with the environmental temperature.
- c) In cold weather, auxiliary devices are needed to start the machines.

**This Page Intentionally Left Blank**

# 2 MACHINE COMPONENTS

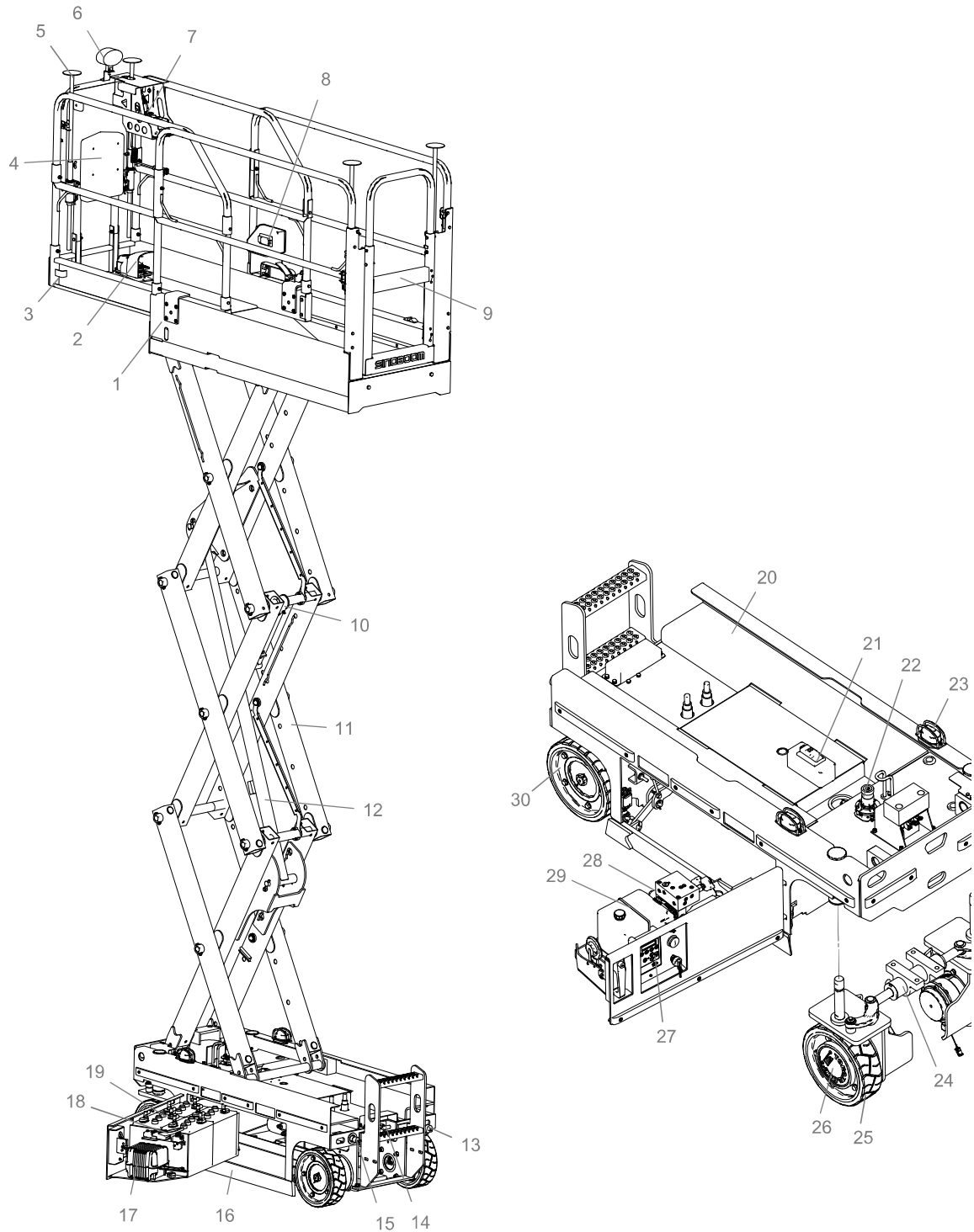


Figure 2-1

| Component                      | China | CE | CSA | ANSI | AS | Japan | Korea | Poland |
|--------------------------------|-------|----|-----|------|----|-------|-------|--------|
| 1. Fixed Platform              |       |    |     | √    |    |       |       |        |
| 2. Foot Switch                 |       |    |     |      |    | √     |       |        |
| 3. Extended Platform           |       |    |     | √    |    |       |       |        |
| 4. Manual Storage Container    |       |    |     | √    |    |       |       |        |
| 5. Overhead Protection         |       |    |     |      |    |       | √     |        |
| 6. Working Light               |       |    |     |      |    |       |       | √      |
| 7. Platform Control Box        |       |    |     | √    |    |       |       |        |
| 8. AC Power Socket             |       |    | √   |      |    |       |       | √      |
| 9. Platform Entry Gate         |       |    |     | √    |    |       |       |        |
| 10. Safety Arm                 |       |    |     | √    |    |       |       |        |
| 11. Scissor Components         |       |    |     | √    |    |       |       |        |
| 12. Lift Cylinder              |       |    |     | √    |    |       |       |        |
| 13. Industrial Plug            |       |    |     | √    |    |       |       |        |
| 14. Emergency Decent Handle    |       |    |     | √    |    |       |       |        |
| 15. Charger Plug               |       |    |     | √    |    |       |       |        |
| 16. Pothole Protection Plate   |       |    |     | √    |    |       |       |        |
| 17. Battery charger            |       |    |     | √    |    |       |       |        |
| 18. Main Power Handle Assembly |       |    |     | √    |    |       |       |        |
| 19. Battery                    |       |    |     | √    |    |       |       |        |
| 20. Chassis                    |       |    |     | √    |    |       |       |        |
| 21. RCBO                       |       |    | √   |      |    |       |       | √      |
| 22. Level Sensor               |       |    |     | √    |    |       |       |        |
| 23. Flash Light                |       |    | √   |      |    |       | √     |        |
| 24. Steer Cylinder             |       |    |     | √    |    |       |       |        |
| 25. Steer Wheel                |       |    |     | √    |    |       |       |        |
| 26. Drive Reducer,DC           |       |    |     | √    |    |       |       |        |
| 27. Ground Controller          |       |    |     | √    |    |       |       |        |
| 28. Power Unit                 |       |    |     | √    |    |       |       |        |
| 29. Hydraulic Oil Tank         |       |    |     | √    |    |       |       |        |
| 30. Rear Wheel                 |       |    |     | √    |    |       |       |        |

# 3 SAFETY

Read, understand and comply with the safety rules and regulations of your workplace and your government.

Before using the machine, obtain proper training on safe machine operation and make sure you can safely control and operate the machine.

Understand that as the operator you have the responsibility and right to shut down the machine in case of failure with the machine or other emergency at your workplace.

## NOTICE

*People suffering from heart disease, hypertension, epilepsy and other diseases and people who fear heights must never operate or use this machine. Also, people who have alcohol or drugs in their system, or experience excessive fatigue or depression, are prohibited from operating or using this machine.*

## SAFETY DEFINITIONS



This safety alert symbol appears with most safety statements. It means attention, become alert, your safety is involved! Please read and abide by the message that follows the safety alert symbol.

## DANGER

Indicates a hazardous situation that, if not avoided, *will* result in death or serious injury.

## WARNING

Indicates a hazardous situation that, if not avoided, *could* result in death or serious injury.

## CAUTION

Indicates a hazardous situation that, if not avoided, *could* result in minor or moderate injury.

## NOTICE

*Indicates a situation that can cause damage to the engine, personal property and/or the environment, or cause the equipment to operate improperly.*

**NOTE:** Indicates a procedure, practice or condition that should be followed in order for the engine or component to function in the manner intended.

## REPORTING ACCIDENTS

In case of any accident involving the machinery of , notify immediately, even if no personal injury or property damage occurs during the accident. Contact by telephone and provide all necessary details. Failure to notify the manufacturer within 48 hours of the incident involving the machinery of may void the product's warranty.





## NOTICE

*Thoroughly inspect the machine and all its functions after any accident, being sure to test first from the ground controller and then from the platform controller. Ensure the machine's lifting height does not exceed 3 m(9.8 ft) until all damage has been repaired and all controllers operate properly.*

## ELECTROCUTION HAZARDS

**NOTE:** This machine is not insulated and does not have an electric shock protection function.

All operators and managers shall comply with national or local regulations regarding the minimum safe distance of live conductors above the ground. In the absence of such requirements, operators and managers should follow the minimum safety distance requirements in *Table 3-1* , *page 3-2*.

|  <b>WARNING</b> |  |
|--|--|
| <b>ELECTRICAL SHOCK HAZARDS</b>  |  |
|                 | <ul style="list-style-type: none"> <li>• <b>Always maintain a safe distance from power lines and electrical equipment in accordance with applicable government regulations and see <i>Table 3-1</i> , page 3-2.</b></li> </ul>   |
|                 | <ul style="list-style-type: none"> <li>• <b>Consider platform movement, wire swinging or drooping, beware of strong winds or gusts, and do not operate the machine when there is lightning or heavy rain.</b></li> </ul>   |
|                 | <ul style="list-style-type: none"> <li>• <b>If the machine comes into contact with live wires, keep away from the machine. Personnel on the ground or on the platform must not touch or operate the machine until the power is switched off.</b></li> <li>• <b>Do not use the machine as a ground wire during welding and polishing operations.</b></li> </ul> |

|                              |                |
|------------------------------|----------------|
| Extending: Extension only    | 120 kg(265 lb) |
| <b>GTJZ0408ME&amp;0608ME</b> |                |
| Retracting                   | 230 kg(507 lb) |
| Extending: Stationary only   | 110 kg(242 lb) |
| Extending: Extension only    | 120 kg(265 lb) |

**Table 3-1**

| <b>Voltage<br/>(Phase to Phase, kV)</b> | <b>Minimum Safe Distance<br/>(m/ft)</b> |
|---|---|
| 0-50                                    | 3.05 (10)                               |
| 50-200                                  | 4.60 (15)                               |
| 200-350                                 | 6.10 (20)                               |
| 350 -500                                | 7.62 (25)                               |
| 500 -750                                | 10.67 (35)                              |
| 750 -1000                               | 13.725 (45)                             |

## TIPPING HAZARDS AND RATED LOAD

Maximum rated load bearing capacity of the platform:

**Table 3-2**

|                              |                |
|------------------------------|----------------|
| <b>GTJZ0408SE&amp;0608SE</b> |                |
| Retracting                   | 280 kg(617 lb) |
| Extending: Stationary only   | 160 kg(352 lb) |



**⚠ WARNING**

**TIPPING HAZARDS**



- Personnel, equipment and materials on the platform must not exceed the maximum load capacity.
- Only raise or extend the platform when the machine is on solid, level ground.
- Do not use the tilt alarm as a level indicator. The tilt alarm on the platform will sound only if the machine is heavily tilted. If the tilt alarm sounds:
  - Be very careful to lower the platform. Transfer the machine to solid, level ground. Do not change the level or limit switch.
- Do not drive faster than 0.8 km/h (0.5 mph) when the platform is raised.
- When the platform is raised, the machine cannot travel on uneven terrain, unstable surfaces or in other dangerous conditions.
- Do not operate the machine during strong winds or gusts, and do not increase the surface area of the platform or load. Increasing the area exposed to the wind will reduce the stability of the machine.
- When the machine is on rough ground, with gravel or other uneven surfaces, or near holes and steep slopes, use caution and reduce the speed.
- When on the platform do not push and pull objects outside of it. The maximum lateral force allowed is:

|             |  |
|-------------|--|
| GTJZ0408SE: | 400 N(90 lbf) indoor                       |
| GTJZ0608SE: | 400 N(90 lbf) indoor                       |
| GTJZ0408ME: | 400 N(90 lbf) indoor/200 N(45 lbf) outdoor |
| GTJZ0608ME: | 400 N(90 lbf) indoor/200 N(45 lbf) outdoor |

**⚠ WARNING**

**TIPPING HAZARDS**

- Do not change any machine parts that may affect safety and stability.
- Do not replace key parts that affect machine stability with different weights or specifications.
- Do not modify or change moving aerial platforms without the manufacturer's prior written permission.
- On the platform, do not attach an additional device for placing tools or other materials to the guardrail. This will increase the platform weight, surface area and load.
- Do not place on, or fasten to, any overhanging load to any part of this machine.
- Do not place ladders or scaffolding on the platform or any parts of the machine.
- Do not use the machine on a moving or active surface or on a vehicle. Ensure all tires are in good condition, the slotted nuts tightened and the cotter pins complete.
- Do not use a battery that weighs less than the original lead acid battery(28 kg [62 lb]) or lithium battery (120 kg [265 lb]). The battery not only provides power, it also serves as a counterweight. The battery is vital to maintaining the stability of the machine.
- Do not use a platform to propel machines or other objects.
- Do not let the platform touch nearby objects.
- Do not tie off the platform with rope or other binding materials to nearby objects.
- Do not put a load outside the platform.
- Do not operate the machine when the chassis doors are open.
- When the platform is caught or stuck or when other objects in the vicinity impede its normal movement, do not use the platform controller to lower the platform. If you intend to lower the platform with a

 **WARNING**
**TIPPING HAZARDS**

ground controller, you must operate it only after all personnel have left the platform.

## WORK ENVIRONMENT HAZARDS

 **WARNING**
**UNSAFE JOBSITE HAZARDS**

- Do not operate the machine on surfaces, edges or potholes that cannot bear the weight of the machine. Raise or extend the platform only when the machine is on firm, flat ground.
- Do not use the tilt alarm as a horizontal indicator. The tilt alarm on the platform will sound only when the machine is heavily tilted.
- If the tilt alarm sounds while lifting the platform, be very careful when lowering the platform. Do not change the level or limit switch.
- Running speed should not exceed 0.8 km/h (0.5 mph) when the platform rises.
- If the machine can be used outdoors, never operate it during strong winds or gusts. Do not lift the platform when the wind speed exceeds 12.5 m/s (28 mph). If the wind speed exceeds 12.5 m/s (28 mph) after the platform is lifted, fold the platform and do not continue to operate the machine.
- Never travel on uneven terrain or unstable surfaces or in other dangerous conditions when raising the platform.
- When the machine retracts, be careful and slow down when the machine is moving on uneven terrain, crushed stone, unstable or smooth surfaces, steep slopes and near cave entrances.
- Do not drive or lift the machine on slopes, steps or vaulted surfaces that exceed the maximum climbing capacity of the machine.

Before or during machine operation, check the possible hazards on the jobsite and beware of the restrictions within the environment, including flammable and explosive gas/dust.

Table 3-3

| BEAUFORT NUMBER | METERS/ SECOND | MILE/ HOUR | DESCRIPTION             | GROUND CONDITION  |
|-----------------|----------------|------------|-------------------------|---|
| 0               | 0 ~ 0.2        | 0 ~ 0.5    | Calm                    | Calm. Smoke rises vertically.   |
| 1               | 0.3 ~ 1.5      | 1 ~ 3      | Light air               | Wind motion visible in smoke.   |
| 2               | 1.6 ~ 3.3      | 4 ~ 7      | Light breeze            | Wind felt on exposed skin. Leaves rustle.   |
| 3               | 3.4 ~ 5.4      | 8 ~ 12     | Gentle breeze           | Leaves and smaller twigs in constant motion.  |
| 4               | 5.5 ~ 7.9      | 13 ~ 18    | Moderate breeze         | Dust and loose paper rise. Small branches begin to move.                                |
| 5               | 8.0 ~ 10.7     | 19 ~ 24    | Fresh breeze            | Smaller trees sway.   |
| 6               | 10.8 ~ 13.8    | 25 ~ 31    | Strong breeze           | Large branches in motion. Flags waving near horizontal. Umbrella use becomes difficult. |
| 7               | 13.9 ~ 17.1    | 32 ~ 38    | Near gale/moderate gale | Whole trees in motion. Effort needed to walk against the wind.                          |
| 8               | 17.2 ~ 20.7    | 39 ~ 46    | Fresh gale              | Twigs broken from trees. Cars veer on road.   |
| 9               | 20.8 ~ 24.4    | 47 ~ 54    | Strong gale             | Light structure damage.   |

**NOTICE**

Maximum climbing ability is suitable for machines with platform retracted.

**Maximum Slope:**

GTJZ0408SE&0608SE: 25% (14°)  
 GTJZ0408ME&0608ME: 25% (14°)

Climbing capacity means the maximum allowable tilt angle of the machine when it is on solid ground and the platform is only capable of carrying one person. As the weight of the machine's platform increases, the machine's climbing capacity reduces.

**UNSAFE OPERATION HAZARDS**

At a minimum, operators must operate and maintain the machine as stated in this manual and in the *Maintenance Manual* in addition to following more stringent industry regulations and workplace rules. Never engage in unsafe machine operation.

### ⚠ WARNING

#### UNSAFE OPERATION HAZARDS



- Do not push any object outside the platform. The maximum lateral force allowed is:



|             |  |
|-------------|--|
| GTJZ0408SE: | 400 N(90 lbf) indoor                       |
| GTJZ0608SE: | 400 N(90 lbf) indoor                       |
| GTJZ0408ME: | 400 N(90 lbf) indoor/200 N(45 lbf) outdoor |
| GTJZ0608ME: | 400 N(90 lbf) indoor/200 N(45 lbf) outdoor |

- Do not change any machine parts that may affect safety and stability.
- Do not replace key parts that affect machine stability with different weights or specifications.
- Do not change or modify moving aerial platforms without the manufacturer's written permission.
- On the platform, do not attach an additional device for placing tools or other materials to the guardrail. This will increase the platform weight, surface area and load.
- Do not put ladders or scaffolding on the platform or any part of this machine.
- Do not use the machine on any mobile or movable surface or vehicle. Ensure all tires are in good condition, the slotted nuts tightened and the cotter pins complete.
- Do not use a battery that weighs less than the original lead acid battery(28 kg [62 lb]) or lithium battery (120 kg [265 lb]). The battery not only provides power, it also serves as a counterweight. The battery is vital to maintaining the stability of the machine.
- Do not place or attach any suspended load onto any part of the machine.
- Do not use the machine as a crane.



### ⚠ WARNING

#### UNSAFE OPERATION HAZARDS

- Do not use the platform to push the machine or other objects.
- Do not allow the platform to touch nearby objects.
- Do not tie the platform onto nearby objects.
- Do not put the load outside the platform.
- When the platform is caught or stuck or when other objects in the vicinity impede its normal movement, do not use the platform controller to lower the platform. If you intend to lower the platform with a ground controller, you must operate it only after all personnel have left the platform.
- Do not operate the machine when the chassis door box is open.
- When one or more of the machine's tires are off the ground, evacuate all personnel before attempting to stabilize the equipment. Use a crane, forklift or other suitable apparatus to stabilize the equipment.



## FALL HAZARDS

At a minimum, operators must operate and maintain the machine as stated in this manual and in the *Maintenance Manual* in addition to following more stringent industry regulations and workplace rules.

**⚠ WARNING**

**FALL HAZARDS**











- Each person on the platform must wear harnesses or use safety equipment consistent with government regulations. Fasten the cable to the fixed point of the platform. Never fasten the cable of more than one person to a fixed point on the platform.
- Do not sit, stand or crawl on the guardrails. When on the platform always remain standing on the platform floor.
- Do not climb down from the platform when the platform is elevated.
- Keep the platform floor free of obstacles.
- Do not enter or exit the platform unless the machine is fully in place.
- Close the platform entrance door before operating the machine.
- Do not operate the machine if the handrails are not properly installed and the platform entry door is not closed.

## COLLISION HAZARDS

At a minimum, operators must operate and maintain the machine as stated in this manual and in the *Maintenance Manual* in addition to following more stringent industry regulations and workplace rules.

**⚠ WARNING**

**COLLISION HAZARDS**

- Pay attention to the field of sight and the presence of blind spots when moving or operating the machine.
- Pay attention to the extended platform when moving the machine.
- Check the work area to avoid ground and overhead obstructions or other possible risks.
- Be sure to exercise caution when using the platform controller and chassis controller. Color-marked directional arrows show the function of travel, lift and steering.
- Users must comply with user, workplace and government rules regarding the use of personal protective equipment (hard hats, safety belts and gloves, etc.).
- Place the machine on level ground or in a secured position before releasing the brakes.
- Only lower the platform when there are no people or obstructions in the area beneath it.
- Limit the speed of travel according to ground conditions, crowding, gradients, the presence and location of personnel and any other factors that may cause collisions.
- Do not operate the machine on any crane or overhead traveling device unless the crane control is locked or precautions have been taken to prevent any potential collision.
- Do not place your hands and arms where they may become crushed or trapped.
- Do not work in or under the platform or near the scissor arms when the safety lever is not in place.
- Maintain good judgment and planning when using the controller on the ground to operate the machine. Maintain proper distance between operator, machine and fixed object.

**⚠ WARNING****COLLISION HAZARDS**

- Never operate a machine dangerously or for fun.

**CRUSH HAZARDS**

A potential crush hazard exists during movement of the machine. Always keep body parts and clothing a safe distance from the machine during machine operation.

**⚠ WARNING****CRUSH HAZARDS**

- Do not place your hands and arms where they may become crushed or trapped.
- Do not work in or under the platform or near the scissor arms when the safety lever is not in place.
- Maintain good judgment and planning when using the controller on the ground to operate the machine. Maintain proper distance between operator, machine and fixed object.

**EXPLOSION AND FIRE HAZARDS****⚠ WARNING****EXPLOSION AND FIRE HAZARD**

Do not use the machine or charge the battery in hazardous or potentially flammable or explosive atmospheres.

**DAMAGED MACHINE HAZARDS****NOTICE**

To avoid machine damage, follow all operation and maintenance requirements in this manual and the Maintenance Manual.

**⚠ WARNING****UNSAFE OPERATION HAZARDS**

- Do not use the machine if it is damaged or not in proper operating condition.
- Thoroughly inspect and test for all functions of the machine before use. Immediately mark and stop damaged or faulty machines.
- Ensure that all maintenance operations have been performed in accordance with this manual and the corresponding *Maintenance Manual*.
- Make sure all labels are in place and are legible.
- Ensure that the *Operation Manual* and *Maintenance Manual* are sound, easy to read and stored in the storage compartment on the platform.

**BODILY INJURY HAZARDS**


Always follow all operation and maintenance requirements in this manual and the .

**⚠ WARNING****UNSAFE OPERATION HAZARD**



Do not operate the machine when there are oil spills/leaks. Oil spills or leaks in hydraulic fluids may penetrate and burn the skin.

**NOTE:** The operator must carry out maintenance during the pre-operation inspection only. During operation, keep the left and right doors of the chassis closed and locked. Only trained service personnel can open the left and right doors to repair the machine.


## BATTERY HAZARDS

 **WARNING**


**FIRE AND EXPLOSION HAZARD**


- Batteries contain sulfuric acid and generate explosive mixtures of hydrogen and oxygen gases. Keep any device that may cause sparks or flames (including cigarettes/smoking materials) away from the battery to prevent explosion.
- Do not touch the battery terminals or cable clips with tools that may cause sparks.

 **WARNING**


**BATTERY HAZARD**




Always wear protective glasses or goggles and protective clothing when working with batteries. Remove all rings, watches and other accessories.

 **WARNING**


**CHEMICAL BURN HAZARD**



Avoid spilling or contacting battery acid with unprotected skin. Seek medical attention immediately if battery acid contacts skin.

 **WARNING**

**BATTERY HAZARD**



- Do not use any battery charger greater than 24VDC to charge the battery. Only connect the charger to a grounded three-wire AC outlet. Be sure the charger is in proper operating condition before using.
- Be sure to use the appropriate number of personnel and proper lifting methods when changing the battery.

**NOTICE**

After charging the battery, be sure that:

- The battery cable connections are free of corrosion.
- The battery hold-down and cable connections are secured.

*Adding terminal protection and anti-corrosion sealants will help reduce corrosion of the battery terminals and cables.*

## CHARGING THE BATTERY

- Do not expose the battery or charger to water or rain during charging.
- Keep a charging battery away from direct sunlight.
- Always charge the battery using the charger supplied by the manufacturer.

## HANDLING THE BATTERY

- Only trained personnel with permission from the workplace may remove a battery from a machine.
- Never force a battery during installation or removal. Never drop a battery.
- Never short-circuit the outlet of the battery pack directly with the wire.
- If battery acid spills, use water mixed with bicarbonate (baking soda) to neutralize the acid.
- Do not store batteries in wet places or in water.
- Check the wire for damage daily. Replace any damaged parts before operation.

## WELDING AND POLISHING REQUIREMENTS

Before welding, grinding and polishing operations, always ensure you read and understand all operation and maintenance requirements in this manual and the *Maintenance Manual*.

 **WARNING****WELDING HAZARDS**

- **Comply with the welder manufacturer's recommendations for procedures concerning proper use of the welder.**
- **Welding leads or cables may only be connected after turning off the power unit.**
- **Carry out welding operations only after the welding cable has been correctly connected.**
- **Do not use the machine as a ground wire during welding operation.**
- **At all times, make sure that the power tools are completely stored in the working platform. Do not hang the power tools on the railing of the working platform or the work area outside the working platform, or hang the power tools directly by the wire.**

Before performing welding, grinding and polishing work, welders must seek permission of the responsible department at the workplace.

## AFTER USING THE MACHINE

1. Choose a safe parking location that is on sturdy, level ground and that is free of obstructions. Avoid areas with heavy traffic.
2. Lower the platform.
3. Turn the emergency stop switch of the ground controller to the "OFF" position
4. Turn the key switch to the "OFF" position and remove the key to avoid unauthorized use of the machine.
5. Block the wheels with the wheel wedges.
6. Charge the battery.

**NOTICE**

*After using the machine, the power off switch must be disconnected.*



# 4 JOBSITE INSPECTION

## WARNING

### UNSAFE OPERATION HAZARD



**Be sure to follow the instructions and safety rules in this manual. Failure to follow the instructions and safety rules in this manual may result in death or serious injury.**

**Do not operate this machine unless you have learned and practiced the rules for safely operating the machine as stated in this manual.**

- **Know and understand the safety rules before continuing the next step.**
- **Avoid dangerous situations.**
- **Always check the machine before operating.**
- **Select appropriate machinery and personal protective equipment (hard hats, safety belt and gloves, etc.) for the task.**
- **Always perform a pre-operation inspection.**
- **Always perform a pre-operation function test before using the machine.**
- **Check the work site.**
- **Check the safety decals/ nameplate on the machine.**
- **Only use the machine according to the instructions in this manual and for its intended purpose.**

- Unstable or ultra-smooth surfaces
- Overhead obstacles and high-voltage wires
- Hazardous locations
- Ground surface that could fail to support the capacity of the machine and its load
- Gusts and strong winds
- Actions by unauthorized personnel
- Other possible unsafe conditions

During the jobsite inspection the operator determines whether the jobsite is suitable for safe machine operation. The operator should conduct the jobsite inspection before moving the machine to the jobsite.

Safety is the operator's responsibility. Part of safety is conducting a thorough jobsite inspection. Operators must identify and avoid workplace hazards when moving, installing and operating the machine.

The following items present danger on the jobsite:

- Steep hills or caves
- Ground prominences, obstacles or debris
- Ground inclines

**This Page Intentionally Left Blank**

# 5 PRE-OPERATION INSPECTION

## WARNING

### UNSAFE OPERATION HAZARD



**Be sure to follow the instructions and safety rules in this manual. Failure to follow the instructions and safety rules in this manual may result in death or serious injury.**

**Do not operate this machine unless you have learned and practiced the rules for safely operating the machine as stated in this manual.**

- **Know and understand the safety rules before continuing the next step.**
- **Avoid dangerous situations.**
- **Always check the machine before operating.**
- **Select appropriate machinery and personal protective equipment (hard hats, safety belt and gloves, etc.) for the task.**
- **Always perform a pre-operation inspection.**
- **Always perform a pre-operation function test before using the machine.**
- **Check the work site.**
- **Check the safety decals/ nameplates on the machine.**
- **Only use the machine according to the instructions in this manual and for its intended purpose.**

the machine has obvious problems before the operator performs a pre-operation function test.

- The pre-operation inspection also helps the operator determine whether the machine requires routine maintenance.
- See the list of machine components on **2 Machine Components, page 2-1**. Check the machine for any modified, damaged, loose or missing parts.
- Never use a machine that has damaged or modified parts. Mark the machine and stop using the machine if you discover damage or modifications.
- Only qualified maintenance technicians can repair the machine according to the manufacturer's regulations. After any maintenance, the operator must perform another pre-operation inspection before conducting a pre-operation function test.
- Qualified maintenance technicians must perform regular maintenance inspections according to the requirements in the manufacturer's *Maintenance Manual*.

## WARNING

### TIPPING HAZARD



**Do not change or modify the aerial work platform without the prior written permission of the manufacturer. If an additional device is installed on the platform or guardrail for placing tools or other materials, this will increase the platform weight and surface area or increase the load.**

## TIPS FOR CONDUCTING A PRE-OPERATION INSPECTION

- The operator is responsible for performing the "pre-operation inspection" and routine maintenance as stated in this manual.
- Before each shift change, the operator must conduct a pre-operation inspection to find out whether

## CONDUCTING A PRE-OPERATION INSPECTION

Before starting the machine, check whether it meets the following requirements:

- Ensure the *Operation Manual* and *Maintenance Manual* are in good condition, legible and stored in the storage compartment on the platform.
- Make sure all labels are legible and appropriately located.
- Check for hydraulic oil leaks. Check for proper oil level. Add oil as needed. See *Inspect Hydraulic Oil Level, page 5-2*.

- Check battery for leaks and proper liquid level. Add distilled water as needed. See *Inspecting the Battery, page 5-2*.
- Check whether the protective device in use matches the type of work performed and conforms to relevant technical standards.

## INSPECTING PARTS

Check the machine for any damaged, improperly installed, loose or missing parts and unauthorized changes:

- Electrical components, wirings and cables
- Hydraulic power unit, fuel tank, connector, hose, hydraulic cylinder and valve block
- Storage battery pack and its connection
- Drive motor and brake
- Wheels
- Safety arm
- Limit switch and horn
- Alarms and indicator lamps
- Nuts, bolts and other fasteners
- Platform entry door
- Pothole guard device
- Platform in extended state
- Scissor arm (pivoting) and fastener
- Platform joystick

## INSPECTING ENTIRE MACHINE

Inspect the entire machine for damage:

- Cracks in a weld joint or structural part
- Dents or other damage
- Severe rust, corrosion or oxidation
- Missing or loose structural parts and key components, including fasteners and pins for correct positioning and tightness
- The folding platform's ability to support the platform side rail and proper installation of safety pin with wire rope

## INSPECT HYDRAULIC OIL LEVEL

Maintaining the proper hydraulic oil level is critical to the machine's ability to function. An improper hydraulic oil level will damage the hydraulic parts of the machine. Inspecting the hydraulic oil level as part of a daily machine inspection can reveal potential problems in the hydraulic system.

Perform the following procedures with the platform retracted:

1. Open the right door and inspect the side of the hydraulic oil tank. The hydraulic oil level should appear within the "max" and "min" mark in the oil tank.
2. Add hydraulic oil as needed. Never overfill the tank.

**Table 5-1**

| CUSTOMER REQUIREMENTS   | HYDRAULIC OIL MARK                        |
|---|---|
| Normal-temperature region<br>0°C to 40°C (32°F to 104°F)  | L-HM46                                    |
| Cold region<br>-25°C to 25°C (-13°F to 77°F)  | L-HV32                                    |
| High-temperature region<br>greater than 40°C (104°F)  | L-HM68                                    |
| Extremely cold region<br>less than -30°C (-22°F)  | Special programmes need to be identified. |
| <b>NOTE:</b> The manufacturer can add different hydraulic oil (based on your requirements) to the machine before leaving the factory. Never mix hydraulic oils. |   |

## INSPECTING THE BATTERY

The condition of the battery affects the performance of the machine. Improper levels of battery electrolyte or damaged cable and wiring may harm battery parts and may pose dangerous conditions.

### NOTICE

*After the battery is fully charged, wear protective gloves for inspection.*

- Check the acidic liquid level of the lead-acid battery. If needed, refill the distilled water through a filling line above the lead-acid battery. Only add enough distilled water to cover the plate. Never overfill the tube at the end of the charging cycle.

- Ensure the connection of the battery cable is not corroded.
- Ensure the battery is firmly in place and the cable wiring is fastened.

**WARNING****BODILY INJURY HAZARD**

**Lead-acid batteries and lead-acid maintenance-free batteries contain acid. Avoid acid overflow or contact with acid in lead-acid batteries and lead-acid maintenance-free batteries.**

**If battery acid spills, use water mixed with bicarbonate (baking soda) to neutralize the acid.**

**NOTE:** Add wiring end protectors and antiseptic sealants to help eliminate corrosion of the battery terminals and cables.

**This Page Intentionally Left Blank**

# 6 PRE-OPERATION FUNCTION TEST

## WARNING

### UNSAFE OPERATION HAZARD



Be sure to follow the instructions and safety rules in this manual. Failure to follow the instructions and safety rules in this manual may result in death or serious injury.

Do not operate this machine unless you have learned and practiced the rules for safely operating the machine as stated in this manual.

- Know and understand the safety rules before continuing the next step.
- Avoid dangerous situations.
- Always check the machine before operating.
- Select appropriate machinery and personal protective equipment (hard hats, safety belt and gloves, etc.) for the task.
- Always perform a pre-operation inspection.
- Always perform a pre-operation function test before using the machine.
- Check the work site.
- Check the safety decals/ nameplate on the machine.
- Only use the machine according to the instructions in this manual and for its intended purpose.

Conducting a pre-operation function test helps you discover potential problems before you start using the machine. The operator must test all machine functions according to the instructions in this manual.

Do not use a machine with problems or malfunctions. Mark the machine and do not use it if you discover any problems. Only qualified maintenance technicians can repair the machine according to the manufacturer's regulations.

After any maintenance, the operator must perform another pre-operation inspection before conducting a pre-operation function test.

## PREPARING FOR A PRE-OPERATION FUNCTION TEST

Before beginning a pre-operation function test:

1. Select a test area that has a solid, flat, level surface.
2. Ensure the test area is free of obstacles.
3. Connect the battery to the machine if it is not already connected.

## TESTING THE GROUND CONTROLLER

### NOTICE

Test the ground controller in one cycle.

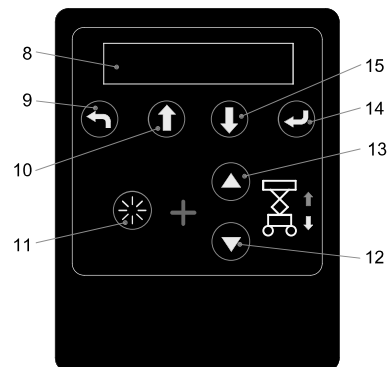
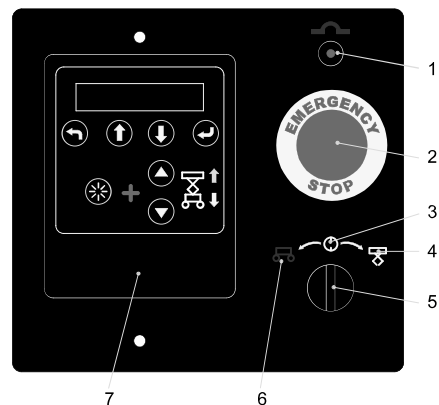


Figure 6-1

- |                              |                   |
|------------------------------|-------------------|
| 1. Insurance                 | 9. Backspace Key  |
| 2. Emergency Stop Button     | 10. Page Up Key   |
| 3. OFF Position              | 11. Enabling Key  |
| 4. Platform Control Position | 12. Lowering Key  |
| 5. Key Switch                | 13. Lifting Key   |
| 6. Ground Control Position   | 14. Enter Key     |
| 7. Controller                | 15. Page Down Key |
| 8. Display Screen            |                   |

## TESTING THE GROUND CONTROLLER FUNCTION



1. Push the emergency stop button on the ground controller and platform controller to the ON position.
2. Turn the key switch to the ground control position.
3. Ensure the relevant indicator turns on and does not display an error message.

## TESTING THE EMERGENCY STOP FUNCTION



1. Put the emergency stop button on the ground into the OFF position by pressing it. Ensure all functions shut down.
2. Pull out the emergency stop button to the ON position.

## TESTING THE LIFTING AND LOWERING FUNCTIONS



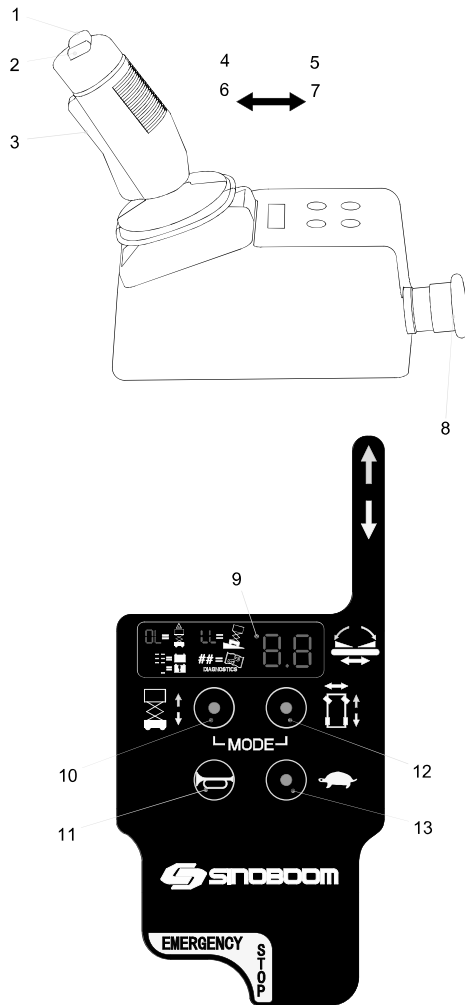
1. Hold down the enabling and lifting key at the same time to start the lifting function. Ensure the platform lifts.
2. Release either the enabling or lifting key to ensure that the platform stops lifting.
3. Hold down the enabling key and lowering key at the same time to start the lowering function. The platform should lower and the alarm should ring.

## TESTING THE PLATFORM CONTROLLER

### NOTICE

*Test all functions of the platform controller in one cycle.*

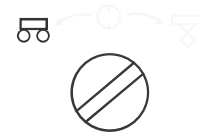




**Figure 6-2**

- |                 |                          |
|-----------------|--------------------------|
| 1. Right        | 8. Emergency Stop Button |
| 2. Left         | 9. Display Screen        |
| 3. Enabling Key | 10. Lifting/Lowering     |
| 4. Lifting      | 11. Horn                 |
| 5. Lowering     | 12. Walking and Steering |
| 6. Front        | 13. High/Low Speed       |
| 7. Back         |                          |

### TESTING THE PLATFORM CONTROLLER



1. Push the emergency stop button on the ground controller and platform controller to the ON position.
2. Turn the key switch of the ground controller to the platform control position.

### TESTING THE EMERGENCY STOP FUNCTION



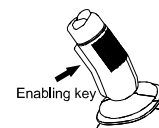
1. Put the emergency stop button on the platform into the OFF position by pressing it. Ensure all functions stop.
2. Pull the emergency stop button to the ON position.

### TESTING THE HORN



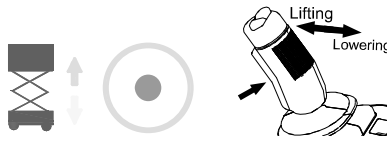
Press the horn button. The horn should sound.

### TESTING THE ENABLING KEY FUNCTION



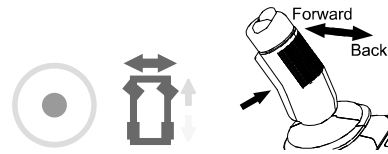
Do not press the enabling key on the control handle. Push the control handle forward and backward. Ensure that all walking and lifting functions stop working.

## TESTING THE LIFTING AND LOWERING FUNCTIONS



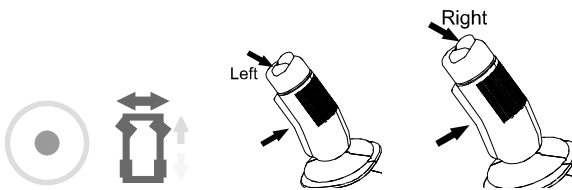
1. Press the lifting/lowering button. The button should illuminate.
2. Hold the enabling key on the control handle and push the control handle forward to activate the lifting function. The platform should rise and the pothole guard device should extend.
3. Release the control handle. Ensure the platform stops lifting.
4. Hold the enabling key of the control handle and push the control handle back to activate the lowering function. Ensure the platform lowers while the lowering alarm sounds.

## TESTING THE DRIVING AND BRAKING FUNCTIONS



1. Press the driving and steering button. The button should illuminate.
2. Hold the enabling key of the control handle and push it forward slowly until the machine begins to move forward, then return the handle to the center position. Ensure the machine moves forward and then stops.
3. Hold the enabling key of the control handle and push it forward slowly until the machine begins to move back, then return the handle to the center position. Ensure the machine moves backward and then stops.

## TESTING THE STEERING FUNCTION



1. Press the driving and steering button. The button should illuminate.
2. Hold the enabling key on the control handle and press the left button. Ensure the machine turns left.
3. Hold the enabling key of the control handle and press the right button. Ensure the machine turns right.

### NOTICE

*The brake must be able to climb at any gradient and the brake must be able to stop the machine.*

## TESTING THE DRIVE SPEED

1. Push the emergency stop button on the ground controller and platform controller to the ON position.
2. Turn the key switch on the ground to the platform control position.
3. Press the lifting/lowering button. The button should illuminate.
4. Hold the enabling key of the control handle and push the control handle forward to activate the lifting function. Ensure the platform lifts about 2 m (6.6 ft). Ensure the pothole guard device (one under the left side of the chassis and one under the right side of the chassis) extends.
5. Press the walking and steering button, hold the enabling key on the control handle and gently push the control handle forward to the full-drive position. Ensure the machine does not take less than 45 seconds to travel 10 m (32.8 ft).

### NOTICE

*If the machine takes less than 45 seconds to travel 10 m (32.8 ft), stop the machine and determine the cause.*

6. Press the lifting/lowering button. Hold the enabling key of the control handle and push the control handle reverse to activate the lowering function.
7. Press the walking and steering button, then press the "High/Low Speed" button. The slow mode activates when the light of the low-speed traveling button illuminates.
8. Hold the enabling key on the control handle and gently push the control handle forward to the full-drive position. Ensure the machine does not take less than 18 seconds to travel 10 m (32.8 ft).

### NOTICE

*If the machine takes less than 18 seconds to travel 10 m (32.8 ft), stop the machine and determine the cause.*

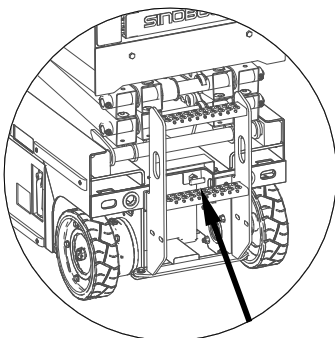
9. Press the "High/Low Speed" button. The light of the low-speed traveling button goes out.
10. Hold the enabling key on the control handle and gently push the control handle forward to the full-drive position. Ensure the machine does not take less than 9 seconds to travel 10 m (32.8 ft).

### NOTICE

*If the machine takes less than 9 seconds to travel 10 m (32.8 ft), stop the machine and determine the cause.*

## TESTING THE EMERGENCY LOWERING FUNCTION

1. Push the emergency stop button on the ground controller and platform controller to the ON position.
2. Turn the key switch on the ground to the ground control position.
3. Move the ground lifting/lowering switch up and raise the platform to the highest position.
4. Pull out the emergency lowering handle located behind the chassis.



**Figure 6-3**

5. The platform shall descend to the lowest position.

## TESTING THE TILT PROTECTION FUNCTION

### NOTICE

*Perform this step while you are standing on the ground using the platform controller. Do not stand on the platform while testing this function.*

To operate the lower part of the scissor arm, use the safety arm; otherwise serious personal injury may result.

1. Lifting the platform, open the safety arm and ensure the safety arm functions.
2. Flip the level switch to exceed 1.5 degrees in the left-to-right direction. Ensure the machine sounds an alarm.
3. Flip the level switch to exceed 3 degrees in the front-to-back direction. Ensure the machine sounds an alarm.
4. Lower the platform completely.
5. Place the two wooden boards under the two wheels on the left or right side of the machine, and then drive the machine onto the two boards. The wooden boards should measure as follows(L × W × H):

GTJZ0408SE: 50 mm × 100 mm × 18 mm  
(2 in. × 4 in. × 0.7in.)

GTJZ0608SE: 50 mm × 100 mm × 18 mm  
(2 in. × 4 in. × 0.7in.)

GTJZ0408ME: 50 mm × 100 mm × 20 mm  
(2 in. × 4 in. × 0.79in.)

GTJZ0608ME: 50 mm × 100 mm × 20 mm  
(2 in. × 4 in. × 0.79in.)

6. Change the machine's walking function to a platform lifting function and then push the handle to raise the platform about 2 m (6.6 ft). Ensure the platform stops moving and tilt the alarm bell. Ensure the platform controller and the ground controller display the letters "LL."
7. Completely lower the platform. Change the machine's platform lifting function to a walking function. Drive the machine down and remove the wooden boards.
8. Place the two wooden boards under the two wheels on the front or back side of the machine, and then

drive the machine onto the two boards. The wooden boards should measure(L × W × H):

- GTJZ0408SE: 50 mm × 100 mm × 70 mm (2 in. × 4 in. × 2.8in.)
- GTJZ0608SE: 50 mm × 100 mm × 70 mm (2 in. × 4 in. × 2.8in.)
- GTJZ0408ME: 50 mm × 100 mm × 70 mm (2 in. × 4 in. × 2.8in.)
- GTJZ0608ME: 50 mm × 100 mm × 70 mm (2 in. × 4 in. × 2.8in.)

9. Change the machine’s walking function to a platform lifting function and then push the handle to raise the platform about 2 m (6.6 ft). Ensure the platform stops moving and tilt the alarm bell. Ensure the platform controller and the ground controller display the letters “LL.”
10. Completely lower the platform. Change the machine’s platform lifting function to a driving function. Drive the machine down and remove the wooden boards.

1. Test the pothole guard. Ensure that the pothole guard activates automatically when the platform lifts to the level of the fork and leaves the pressure lever of the pothole guard.
2. Push hard on the left/right pothole guard shield. Ensure the pothole guard shield cannot be flipped upward.
3. Lower the platform. Ensure that the pothole guard shield automatically recovers.
4. Place a wooden board under the pothole guard and lift the platform. The wooden boards should measure(L × W × H): 50 mm × 100 mm × 50 mm (2 in. × 4 in. × 2 in.). When the platform lifts to the level of the fork and leaves the pothole guard lever, the alarm will sound and the platform controller and ground controller will display the number “18”. The machine will not be able to lift and drive.
5. Completely lower the platform and remove the wooden blocks.

## TESTING THE POTHOLE GUARD

### NOTICE

*When the platform lifts, the pothole guard should activate automatically. The pothole guard activates two limit switches to help restrict the movement of the machine. When the platform rises to the level of the fork and leaves the pressure lever of the pothole guard, the pothole guard activates. If the pothole guard does not activate, the alarm will sound and the machine will not be able to lift and drive.*

## TESTING THE WEIGHING SYSTEM(OPTIONAL)

1. Before conducting this test, fully lift and lower the platform twice to ensure normal lubrication of the slider and track.
2. Lower the platform to the minimum height. With the scissor arm fully retracted, gradually add a load to the platform.

Table 6-1

| Models     | Test Results  |
|------------|---|
| GTJZ0408SE | When the weight does not exceed 280 kg (617 lb), ensure that the platform is able to lift to the highest position.<br>When the platform load is greater than or equal to 335 kg (739 lb), if the platform lifting height is greater than 1 m(3.3 ft) or 10% of the height that can be lifted (use the greater number), several things will happen. The overload indicator lamp will illuminate, an alarm will sound, and the work platform will not be able to move. Once you remove the excess weight, the work platform will be able to move again. |
| GTJZ0608SE | When the weight does not exceed 230 kg (507 lb), ensure that the platform is able to lift to the highest position.<br>When the platform load is greater than or equal to 275 kg (606 lb), if the platform lifting height is greater than 1 m(3.3 ft) or 10% of the height that can be lifted (use the greater number), several  |

| Models            | Test Results   |
|-------------------|--|
|                   | things will happen. The overload indicator lamp will illuminate, an alarm will sound, and the work platform will not be able to move. Once you remove the excess weight, the work platform will be able to move again.   |
| <b>GTJZ0408ME</b> | <p>When the weight does not exceed 280 kg (617 lb), ensure that the platform is able to lift to the highest position.</p> <p>When the platform load is greater than or equal to 335 kg (739 lb), if the platform lifting height is greater than 1 m(3.3 ft) or 10% of the height that can be lifted (use the greater number), several things will happen. The overload indicator lamp will illuminate, an alarm will sound, and the work platform will not be able to move. Once you remove the excess weight, the work platform will be able to move again.</p> |
| <b>GTJZ0608ME</b> | <p>When the weight does not exceed 230 kg (507 lb), ensure that the platform is able to lift to the highest position.</p> <p>When the platform load is greater than or equal to 275 kg (606 lb), if the platform lifting height is greater than 1 m(3.3 ft) or 10% of the height that can be lifted (use the greater number), several things will happen. The overload indicator lamp will illuminate, an alarm will sound, and the work platform will not be able to move. Once you remove the excess weight, the work platform will be able to move again.</p> |

**This Page Intentionally Left Blank**

# 7 OPERATING THE MACHINE

## WARNING

### UNSAFE OPERATION HAZARD



Be sure to follow the instructions and safety rules in this manual. Failure to follow the instructions and safety rules in this manual may result in death or serious injury.

Do not operate this machine unless you have learned and practiced the rules for safely operating the machine as stated in this manual.

- Know and understand the safety rules before continuing the next step.
- Avoid dangerous situations.
- Always check the machine before operating.
- Select appropriate machinery and personal protective equipment (hard hats, safety belt and gloves, etc.) for the task.
- Always perform a pre-operation inspection.
- Always perform a pre-operation function test before using the machine.
- Check the work site.
- Check the safety decals/ nameplate on the machine.
- Only use the machine according to the instructions in this manual and for its intended purpose.

This section provides specific instructions for all the aspects of machine operation. The operator is responsible for following all the safety rules and instructions in this manual.

Use this machine to transport people and tools to the workplace. It is unsafe and dangerous to use this machine for purposes other than what is stated in this manual.

Only trained and authorized personnel may operate the machine. If more than one operator uses the same machine at different times of the same work shift, they must all be qualified operators and follow all the safety rules and instructions in this *Operation Manual*.

Each new operator must perform the pre-operation inspection, pre-operation function test, and workplace checks before using the machine.

## USING THE EMERGENCY STOP FUNCTION

1. Place the emergency stop button on the platform controller or ground controller in the OFF position. All functions will stop.
2. This machine has a power off button on the chassis. Put the button into the OFF position. The system will power off and all functions will stop.
3. To restore operation, move the emergency stop button and the power off button into the ON position.

## NOTICE

If the platform controller display the number "02", press the emergency stop button immediately.

## USING THE EMERGENCY LOWERING FEATURE

Pull out the emergency lowering handle to activate the machine's emergency stop function.

See *Testing the Emergency Lowering Function*, page 6-5 for the emergency lowering handle position.

## USING THE EMERGENCY PULL/DRAW FEATURE

### WARNING

#### CRUSH HAZARDS

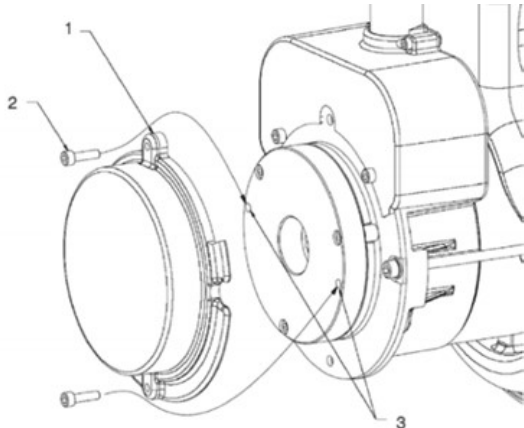


The machine is on any slope and must fully cover the wheels before releasing the brakes, any failure to comply with this warning may result in injury or even death.

When there's an emergency, machine malfunction or power loss need emergency pull/drag, release brake has the following two methods:

**Method 1:**

1. Wedge the tires to prevent the machine from rolling.
2. Ensure the area is free of obstructions.
3. Make sure the battery power OFF switch is in the "OFF" position.
4. Remove two end cover bolts and brake cover.



**Figure 7-1**

**Table 7-1**

| No. | Description           |
|-----|-----------------------|
| 1   | Brake cover           |
| 2   | Brake end cover bolts |
| 3   | bolt hole             |

5. Insert the end cover bolt into the two separate holes on the brake housing.
6. Tighten the end cap bolts downward and the brakes on the drive motor will detach.
7. The above steps are repeated in the drive of the other wheel. after the two drive motors have separated, the machine can be moved by human power.
8. After traction, pad the wheel and remove the end cover bolt from the separation hole.

**Method 2:**

1. Turn the key switch of the ground controller to the ground control position.
2. Push the emergency stop button on the platform controller to the ON position.
3. Push the emergency stop button on the ground controller to the ON position while holding down the enter button for five seconds, and the program setting interface appears on the display screen.

4. Press page down key until the display appears "Machine Mode", then press the enter button.
5. Press page down key until the display appears "Break Release", then press the enter button.
6. At this time, the horn sounded, while the buzzer sounded all the time, the brake was released successfully.
7. the machine can be moved by human power.

## OPERATING ON THE GROUND

**Before operating the machine:**

1. Switch the key switch on the ground controller to the ground control position.
2. Pull the emergency stop button on the ground controller out to the ON position.
3. Ensure the battery is connected to the machine before operating the machine.

**To adjust the platform position:**

1. Operate the lifting/lowering switch on the ground controller to control the lifting and lowering functions of the platform.
2. The ground controller will be unable to control the machine's driving and steering functions.

## OPERATING ON THE PLATFORM

**Before operating the machine:**

1. Switch the key switch on the ground controller to the platform control position.
2. Pull the emergency stop button on the ground controller and platform controller out to the ON position.
3. Ensure the battery is connected to the machine before operating the machine.

**To adjust the platform position:**

1. Press the lifting/lowering button of the platform control box, which will illuminate the button.
2. Press and hold the enabling key.
3. Operate the handle according to the lift symbol on the control panel.

**To activate the steering function:**

1. Press the driving and steering button, which will illuminate the button.



2. Press and hold the enabling key.
3. Use the button switch at the top of the control handle to turn the steering wheel.

## NOTICE

*Use the platform controller's color-coded arrow to determine the direction of the wheel rotation.*

### To drive the machine:

1. Press the driving and steering button. The button should illuminate.
2. Press and hold the enabling key.
3. To speed up, move the handle slowly away from the center.
4. To slow down, move the handle slowly to the center position.
5. Stopping causes the control handle to return to the center position or releases the enabling key. Use the platform controller's color-coded arrow to determine the driving direction.

## NOTICE

*Raising the platform and keeping it in the raised position limits the speed of the machine.*

## NOTICE

*The state of the battery will affect the performance of the machine. When the platform display indicates a low battery, the drive speed and lift speed of the machine will decrease.*

### To choose an actuating speed:

1. In the retracted position, the drive controller can operate in two different drive speed modes. The slow mode activates when the light of the low-speed traveling button illuminates. The fast mode activates when the light of the low-speed traveling button is off.
2. Press the low-speed traveling button to select the desired drive speed.

## NOTICE

*When the platform is lifted to the point that the scissor assembly leaves the level of the high- and low-speed limit switch, the low-speed traveling button light will continually flash to indicate that the elevated drive speed is low.*

### To extend and retract the platform:

1. Step on the pedal.

2. Grab and push the extension platform guardrail carefully to extend the extension platform.
3. Press the pedal and pull the platform back for retraction; release the pedal to insert the end of the extension platform into the built-in slots, which will secure the extension platform.

## WARNING

### UNSAFE OPERATION HAZARD



**Do not stand on the platform extension while extending it. Insert the end of the platform extension into the three built-in slots to secure it. Never perform operations on the platform extension when it is not secured in place with the built-in slots.**

### To unfold and fold the platform railings:

The platform railings are designed to fold for convenient transportation. Unfold them when you need to use them again. The machine includes a foldable railing for the platform extension and a foldable railing for the fixed platform. Fasten all parts of the railings at the appropriate positions using the four wire rope safety pins.

1. Completely lower the platform and retract the extension platform.
2. Remove the platform controller from the platform.
3. Reach into the inside of the platform and remove the front two wire rope safety pins from the platform extension. Fold the front railings of the platform extension. Keep your hands away from areas where they may be hurt, crushed or pinched.
4. Fold both sides of the railings, keeping your hands away from areas where they may be hurt, crushed or pinched.
5. Remove the two wire rope safety pins at the rear of the fixed platform.
6. Carefully open the entry door and move it onto the ladder or floor.
7. Fold the door and the right and left railings at the entrance into one unit, keeping your hands away from areas where they may be hurt, crushed or pinched.
8. Fold the railings at both sides, keeping your hands away from areas where they may be hurt, crushed or pinched.

**⚠ WARNING**

**UNSAFE OPERATION HAZARD**



**When using the platform railings, unfold them in the opposite manner in which you first folded them. Use the wire rope safety pins when unfolding the railings at each side to help ensure accurate installation.**

**NOTICE**

*Climbing ability refers to the maximum permissible percentage of the slope when the machine is on solid ground with sufficient traction and the platform is carrying only one person. As the weight of the machine's platform increases, the machine's climbing capacity reduces.*

## OPERATING WITH THE PLATFORM CONTROLLER ON THE GROUND

Before operating the machine with the platform controller on the ground:

1. Keep a safe distance between the operator, machine and fixed platform.
2. Pay attention to the traveling direction of the machine when using the controller.

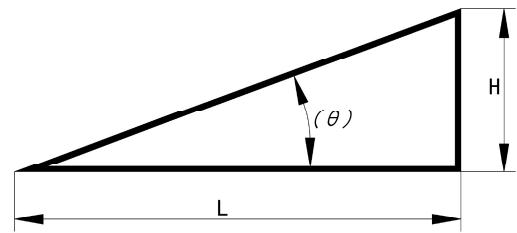
## DRIVING ON A SLOPE

**Before driving on a slope:**

1. Determine the climbing ability of the machine.
  - GTJZ0408SE&0608SE: 25% (14°)
  - GTJZ0408ME&0608ME: 25% (14°)
2. Ensure the platform is fully folded.
3. Ensure that the slope where you plan to drive is less than the angle of the machine's climbing ability.

**To determine the slope:**

1. Use a carpenter's rule, a straight board (longer than 1 m [3.3 ft]), and a tape measure.



**Figure 7-2**

2. Measure the height and length/distance of the slope.
3. The slope measurement consists of the numbers for the height and length/distance x 100%.



**NOTICE**





*To avoid the wheel from dangling, the machine should not be driven for more than 2 minutes on slopes with the maximum climbing capacity allowed, and be sure that the temperature of the motor shell does not exceed 70 °C.*

## USING THE BATTERY LEVEL INDICATOR

Use the diagnostic reading display on the platform to determine the battery level.

**Table 7-2**


| PLATFORM POWER DISPLAY  | POWER RATIO | DESCRIPTION                            |
|---|-------------|--|
|  | 90-100%     | The battery has been fully charged.    |
|  | 70%         | The battery is at 70% of its capacity. |

| PLATFORM POWER DISPLAY  | POWER RATIO | DESCRIPTION  |
|---|-------------|--|
|  | 50%         | The battery is at 50% of its capacity.   |
|  | 30%         | The battery is at 30% of its capacity.   |
|  | 20%         | The battery level is at 20%, which is low. The battery requires recharging.                                    |
|  | 10%         | The battery level is at 10%, which is very low. The machine will become slow. The battery requires recharging. |


## CHARGING THE BATTERY

**⚠ WARNING**


**BATTERY HAZARDS**



**Always read and comply with the battery manufacturer's recommendations for procedures concerning proper battery use and maintenance.**



**Batteries contain sulfuric acid and generate explosive mixtures of hydrogen and oxygen gases. Keep any device that may cause sparks or flames away from the battery to prevent explosion.**



**Always wear protective glasses or goggles and protective clothing when working with batteries. You must follow the battery manufacturer's instructions on safety, maintenance and installation procedures.**

**Always read and comply with the battery manufacturer's recommendations for procedures concerning proper battery use and maintenance.**

**Batteries contain sulfuric acid and generate explosive mixtures of hydrogen and oxygen gases. Keep any device that may cause sparks or flames away from the battery to prevent explosion.**

**Always wear protective glasses or goggles and protective clothing when working with batteries. You must follow the battery manufacturer's instructions on safety, maintenance and installation procedures.**

There are three types of batteries:

- Lead acid (requires maintenance)
- Lead acid (maintenance-free)
- Lithium (maintenance-free)

### To charge a maintenance-free battery:

1. Do not use an external charger.
2. Charge using the correct AC input voltage indicated on the battery's label.
3. Avoid charging the battery in direct sunlight.

Also follow these additional requirements:

1. Make sure the battery is connected to the machine before charging.
2. Connect the battery charger to a grounded AC circuit.
3. Charge the battery as needed after use.

### To charge a lead-acid (requires maintenance) battery:

1. Do not use an external charger.
2. Charge the battery in a well-ventilated area.
3. Charge the battery using the correct AC input voltage indicated on the battery's label.
4. Avoid charging the battery in direct sunlight.

Also follow these additional requirements:

1. Make sure the battery is connected to the machine before charging.
2. Remove the ventilation cover of the lead-acid battery.
3. Check the acidic liquid level of the lead-acid battery. If needed, refill the distilled water through a filling line above the lead-acid battery. Only add enough distilled water to cover the plate. Never overfill during charging.
4. Install the ventilation cover.
5. Connect the lead-acid battery charger to the grounded AC circuit.
6. The charger indicates when the lead-acid battery is fully charged.
7. Check the acid level of the lead-acid battery at the end of the charging cycle. Add distilled water to the

bottom of the tube. Never overfill the tube at the end of the charging cycle.

Table 7-3

## CHANGING CHARGER BATTERY CURVE

| Curve codes | Battery models                                    |
|-------------|---|
| B02         | Trojan T105                                       |
| B04         | Discover AGM                                      |
| B05         | US Battery Flooded                                |
| B07         | Trojan T125                                       |
| B11         | Trojan T1275<br>(two in series and two in tandem) |

**Note:** the default curve code is B02.

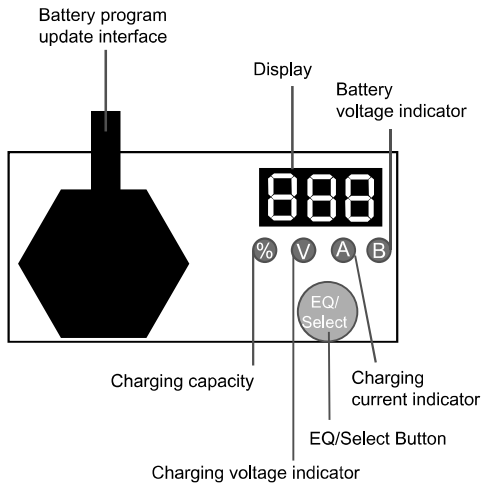


Figure 7-3

### To switch the curve:

1. Press and hold the Select key for 5s and release, the display will indicate the current curve code.
2. Press gently for 1s and release to switch the charging curve codes.
3. After selection of charging curve code, press and hold Select key for 5s, the charging curve code will flash quickly, release the key, and the battery curve has been configured.
4. Repeat the steps above if re-change is needed.

### To enter EQ mode manually:

1. Press and hold Select key for 10s, when the display shows EQ in quick flashing, release the key and the charger has been set in EQ mode.
2. To exit the EQ mode, likewise, press and hold the Select key for 10s, when the display shows OFF in quick flashing, release the key and the charger will exit the EQ mode.

### Charger in-built curve codes and respective battery models

# 8 TRANSPORTING AND LIFTING THE MACHINE

## WARNING

### TRANSPORTATION AND LIFTING HAZARD



- Use a forklift or crane with the proper lifting capacity to lift the machine. Use good judgment and a planned movement to control the machine.
- Transport vehicles must be parked on level ground.
- Be sure to prevent the transportation vehicle from moving when loading the machine. Refer to *1 Performance Parameters, page 1-1*.
- Ensure that the vehicle capacity, loading surface, belts or ropes are sufficient to support the weight of the machine.
- Be sure the machine is on a horizontal plane or fixed before releasing the brakes.
- When removing the wire rope safety pin, prevent the guardrail from falling. The guardrail must be held tight at all times when descending.
- Never transport people on the machine while the machine is being towed or while the machine is engaged in towing or lifting operations.
- When using a forklift or crane to lift the machine, pay attention to prevent the machine from colliding with nearby objects.
- Lock the wheels of the machine after it has been installed to prevent the machine from rolling.

## NOTICE

Do not pull/drag the machine unless an emergency, failure or loss of power occurs. Refer to *Using the Emergency Pull/Drag Feature, page 7-1*.

## LIFTING THE MACHINE WITH A FORKLIFT

Follow these requirements when lifting the machine by forklift:

1. Make sure the platform extension, controller and chassis components are stable. Remove all loose parts from the machine.
2. Fully lower the platform. Keep the platform down during transportation.
3. Use the forklift slots on the rear or side of the chassis

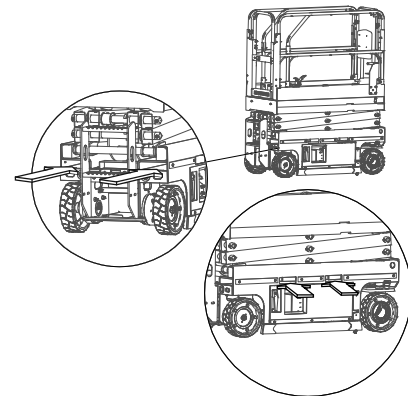


Figure 8-1

4. The forklift fork must align with the position of the forklift slots.
5. Drive forward to the fork frame to insert it fully into the slots.
6. Lift the machine by 16 in. (0.4 m) and then tilt the fork backward slightly to keep the machine stable.
7. Keep the machine horizontal when lowering the fork frame.

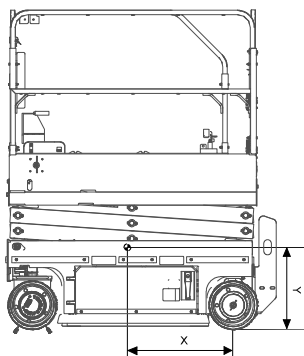
## NOTICE

Failure to use the forklift slot while lifting machine will result in component damage.

## LIFTING THE MACHINE WITH A CRANE

Follow these requirements when lifting the machine by crane:

1. Fully lower the platform. Keep the platform down during transportation.
2. Make sure the platform extension, controller and chassis components are stable.
3. Remove all loose parts from the machine.
4. Determine the center of gravity of the machine, see.

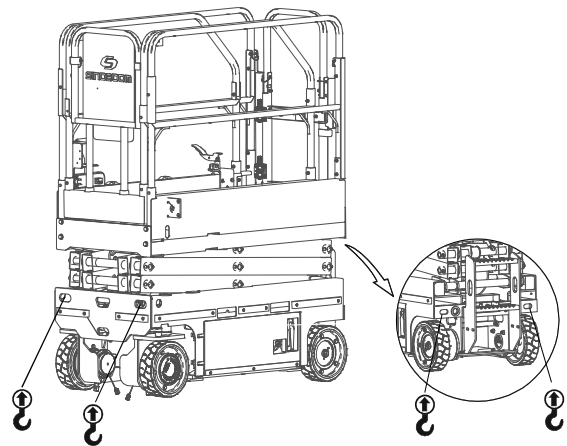


**Figure 8-2**

**Table 8-1**

| Models     | X                    | Y                    |
|------------|----------------------|----------------------|
| GTJZ0408SE | 602 mm<br>(23.7 in.) | 518 mm<br>(20.4 in.) |
| GTJZ0608SE | 651 mm<br>(25.6 in.) | 528 mm<br>(20.8 in.) |
| GTJZ0408ME | 602 mm<br>(23.7 in.) | 519 mm<br>(20.4 in.) |
| GTJZ0608ME | 651 mm<br>(25.6 in.) | 527 mm<br>(20.7 in.) |

5. Lift the machine according to the following figure.



**Figure 8-3**

6. Only connect the rigging to the raised point specified on the machine. Adjust the rigging to avoid damaging the machine and to keep the machine horizontal.

### NOTICE

*To protect the platform guardrail, choose the appropriate length of spreader.*

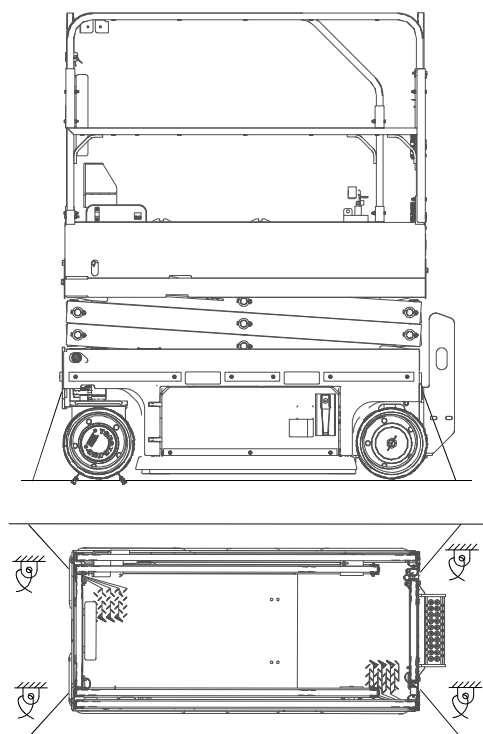
## TRANSPORTING THE MACHINE

**Obey the following requirements when transporting the machine using trucks or trailers:**

1. Before transporting, turn the key switch of the ground controller to the OFF position and then remove the key.
2. Inspect the machine thoroughly for loose parts.
3. Ensure the rope or belt has sufficient load strength.
4. Use at least two ropes or straps.
5. Adjust the rigging to prevent damage to the rope or belt.

### NOTICE

*During transportation, retract the extension platform so that the extension platform is secure at the slots. Ensure that the extension platform cannot extend or shake out of the main platform during transportation.*



**Figure 8-4**

**This Page Intentionally Left Blank**



# 9 MAINTENANCE

This section provides detailed procedures for regular maintenance inspections.

 **WARNING**

**UNSAFE OPERATION HAZARD**



**Failure to follow the proper maintenance may result in death, serious injury or damage to the machine.**

Follow these general rules:

- Professionally trained, qualified personnel must conduct routine maintenance inspections on this machine.
- Daily routine maintenance inspections must occur during normal operation of the machine. Maintenance inspectors must carry out inspection and maintenance according to the repair & inspection report listed in *Table 9-3*, *page 9-3* and must complete the repair & inspection report.
- Regular maintenance inspections must occur by operators and at quarterly, biannual and annual intervals by qualified, trained personnel. Qualified, trained personnel must check and maintain the machine according to the repair & inspection report listed in *Table 9-3*, *page 9-3* and must complete the repair & inspection report.
- Immediately remove a damaged or malfunctioning machine, mark it and stop using it.
- Repair any damaged or malfunctioning machine before operating it.
- Keep all machine inspection records for at least 10 years or until the machine is no longer in use or as required by machine owner/company/custodian.
- Conduct a quarterly inspection on machines that have been out of service for a period lasting longer than three months.
- While maintaining the machine, replace any parts on the machine using the same parts or the same parts of the original machine.
- Unless otherwise specified, perform all maintenance procedures according to the following terms and conditions:
  - Park the machine on flat, level, firm ground.
  - Keep the machine in the stowed position.
  - Ensure the key switch of the ground controller is in the OFF position and remove the key to prevent unauthorized use of the machine.
  - Place the red emergency stop button on the platform control box and ground controller in the OFF position to avoid accidental start-up of the operating system.
  - Disconnect main power switch.
  - Disconnect all DC power from the machine.
  - Lock all wheels to prevent movement of the machine.
  - Before releasing or removing the hydraulic components, release the hydraulic oil pressure in the hydraulic pipeline.

## CONDUCTING A PRE-DELIVERY INSPECTION

When the machine owner/company changes, in addition to conducting a pre-delivery inspection, the corresponding inspection shall be carried out according to the maintenance schedule requirement and repair & inspection report. When conducting a pre-delivery inspection, comply with the following requirements:

1. It is the responsibility of the machine owner/company to perform a pre-delivery inspection.
2. Follow this procedure each time before delivery. Performing a pre-delivery inspection could reveal potential problems with the machine before you begin putting the machine into service.
3. Never use a damaged or malfunctioning machine. Tag the machine and do not use it.
4. Only professionally trained, qualified personnel may repair the machine and must follow the procedures as stated in *operation manual* and *maintenance manual*.
5. A competent operator must conduct daily maintenance on this machine as stated in *operation manual* and *maintenance manual*.

Before delivering the machine, complete the following record using these instructions:

1. Prepare the machine before delivery, which includes performing a pre-delivery inspection, following maintenance procedures and performing functional inspections.

2. Use the following table to note the results. After each section is complete, mark the appropriate box.
3. Record the inspection results. If any inspection results are "NO", the machine must be stopped and

re-inspected after repair is completed and marked in the box marked "inspection".

**Table 9-1**

| <b>PREPARE THE WORK RECORD BEFORE DELIVERY</b> |   |   |   |
|--|---|---|---|
| Model  |   |   |   |
| Serial No.                                     |   |   |   |
| <b>Inspection Item</b>                         | <b>YES/Machine is in Good Condition</b> | <b>NO/Machine Has Damage or Malfunction</b> | <b>REPAIRED/Machine Has Been Repaired</b> |
| Pre-operational Inspection                     |   |   |   |
| Maintenance Procedure                          |   |   |   |
| Functional Inspection                          |   |   |   |
| Machine Buyer/ Renter                          |   |   |   |
| Inspector Signature                            |   |   |   |
| Inspector Title                                |   |   |   |
| Inspector Company                              |   |   |   |

## **FOLLOWING A MAINTENANCE SCHEDULE**

Regular maintenance inspections must occur daily, quarterly, biannually (every 6 months) and annually. Use the table to help you adhere to a routine maintenance schedule.

**Table 9-2**

| <b>INSPECTION INTERVAL</b>           | <b>INSPECTION PROCEDURES</b> |
|--------------------------------------|------------------------------|
| Every day or every 8 hours           | A                            |
| Every quarter or every 250 hours     | A+B                          |
| Every half a year or every 500 hours | A+B+C                        |
| Every year or every 1000 hours       | A+B+C+D                      |

## **COMPLETING A REPAIR & INSPECTION REPORT**

1. Divide the Repair & Inspection Report into four sections (A, B, C and D) according to the time requirements of the maintenance schedule and the maintenance procedure requirements.
2. The Repair & Inspection Report shall include the inspection table of each regular inspection.
3. Duplicate the Repair & Inspection Report for each inspection. Store the completed tables for 10 years or until the machine is no longer in use or as required by machine owner/company/custodian.
4. Use the following table to note the results. After each section is complete, mark the appropriate box.
5. Record the inspection results. If any inspection results are "NO", the machine must be stopped and re-inspected after repair is completed and marked in the box marked "inspection". Select the appropriate inspection procedure based on the inspection type.

**Table 9-3**

| <b>REPAIR &amp; INSPECTION REPORT</b>                            |   |   |   |                            |
|--|---|---|---|----------------------------|
| Model  |   |   |   |                            |
| Serial No.   |   |   |   |                            |
| <b>Checklist A Procedures</b>                                    |   |   |   |                            |
| <b>Items</b>   | <b>YES/Machine is in Good Condition</b> | <b>NO/Machine Has Damage or Malfunction</b> | <b>REPAIRED/Machine Has Been Repaired</b> | <b>Problem Description</b> |
| A-1 Inspect All Manuals  |   |   |   |                            |
| A-2 Inspect All Decals   |   |   |   |                            |
| A-3 Inspect Damaged, Loose or Lost Parts                         |   |   |   |                            |
| A-4 Inspect Hydraulic Oil Level                                  |   |   |   |                            |
| A-5 Inspect Hydraulic Oil Leakage                                |   |   |   |                            |
| A-6 Functional Tests   |   |   |   |                            |
| A-7 Inspect Emergency Lowering Function                          |   |   |   |                            |
| A-8 Test Braking Device  |   |   |   |                            |
| A-9 Full Lifting and Full Lowering Time Test                     |   |   |   |                            |
| A-10 Testing Traveling Speed (Platform is Lifted State)          |   |   |   |                            |
| A-11 Testing Traveling Speed (Platform is Fully Retracted State) |   |   |   |                            |
| A-12 Inspect the Tilt Protection Function                        |   |   |   |                            |
| A-13 Test the Pothole Guard                                      |   |   |   |                            |
| A-14 Inspect Platform Weighing System(optional)                  |   |   |   |                            |
| A-15 Inspect the Raised Limit Function                           |   |   |   |                            |
| A-16 Inspect Platform Lowering Limit                             |   |   |   |                            |
| A-17 Inspect the battery level                                   |   |   |   |                            |
| A-18 Perform Maintenance After 30 Days                           |   |   |   |                            |
| <b>Checklist B Procedures</b>                                    |   |   |   |                            |

| <b>REPAIR &amp; INSPECTION REPORT</b>                    |   |   |   |                            |
|--|---|---|---|----------------------------|
| <b>Items</b>   | <b>YES/Machine is in Good Condition</b> | <b>NO/Machine Has Damage or Malfunction</b> | <b>REPAIRED/Machine Has Been Repaired</b> | <b>Problem Description</b> |
| B-1 Inspect Electric Wires                               |   |   |   |                            |
| B-2 Inspect Rim ,Tire and Fasteners                      |   |   |   |                            |
| B-3 Inspect Battery                                      |   |   |   |                            |
| B-4 Inspect Hydraulic Oil                                |   |   |   |                            |
| B-5 Inspect Hydraulic Oil Tank Ventilation System        |   |   |   |                            |
| B-6 Inspect Brake Manual Release Function                |   |   |   |                            |
| <b>Checklist C Procedures</b>                            |   |   |   |                            |
| <b>Items</b>   | <b>YES/Machine is in Good Condition</b> | <b>NO/Machine Has Damage or Malfunction</b> | <b>REPAIRED/Machine Has Been Repaired</b> | <b>Problem Description</b> |
| C-1 Replace Hydraulic Oil Tank Air Filter                |   |   |   |                            |
| <b>Checklist D Procedures</b>                            |   |   |   |                            |
| <b>Items</b>   | <b>YES/Machine is in Good Condition</b> | <b>NO/Machine Has Damage or Malfunction</b> | <b>REPAIRED/Machine Has Been Repaired</b> | <b>Problem Description</b> |
| D-1 Inspect Scissor Arm Installation Bearing             |   |   |   |                            |
| D-2 Inspect Chassis Slider                               |   |   |   |                            |
| D-3 Replace Hydraulic Oil Tank Return Oil Filter Element |   |   |   |                            |
| D-4 Inspect and Replace Hydraulic Oil                    |   |   |   |                            |
| D-5 Inspect Key Structural Parts                         |   |   |   |                            |
| User   |   |   |   |                            |
| Inspector Signature                                      |   |   |   |                            |
| Inspector Date   |   |   |   |                            |
| Inspector Title  |   |   |   |                            |
| Inspector Company  |   |   |   |                            |



# 10 DECALS/NAMEPLATES INSPECTION

Use appropriate inspection methods to check that all decals are easy to identify and properly placed.

Replace any lost or damaged safety decals.

Clean safety decals with neutral soap and water. Do not use solvent-based cleaners, which can damage safety label materials.

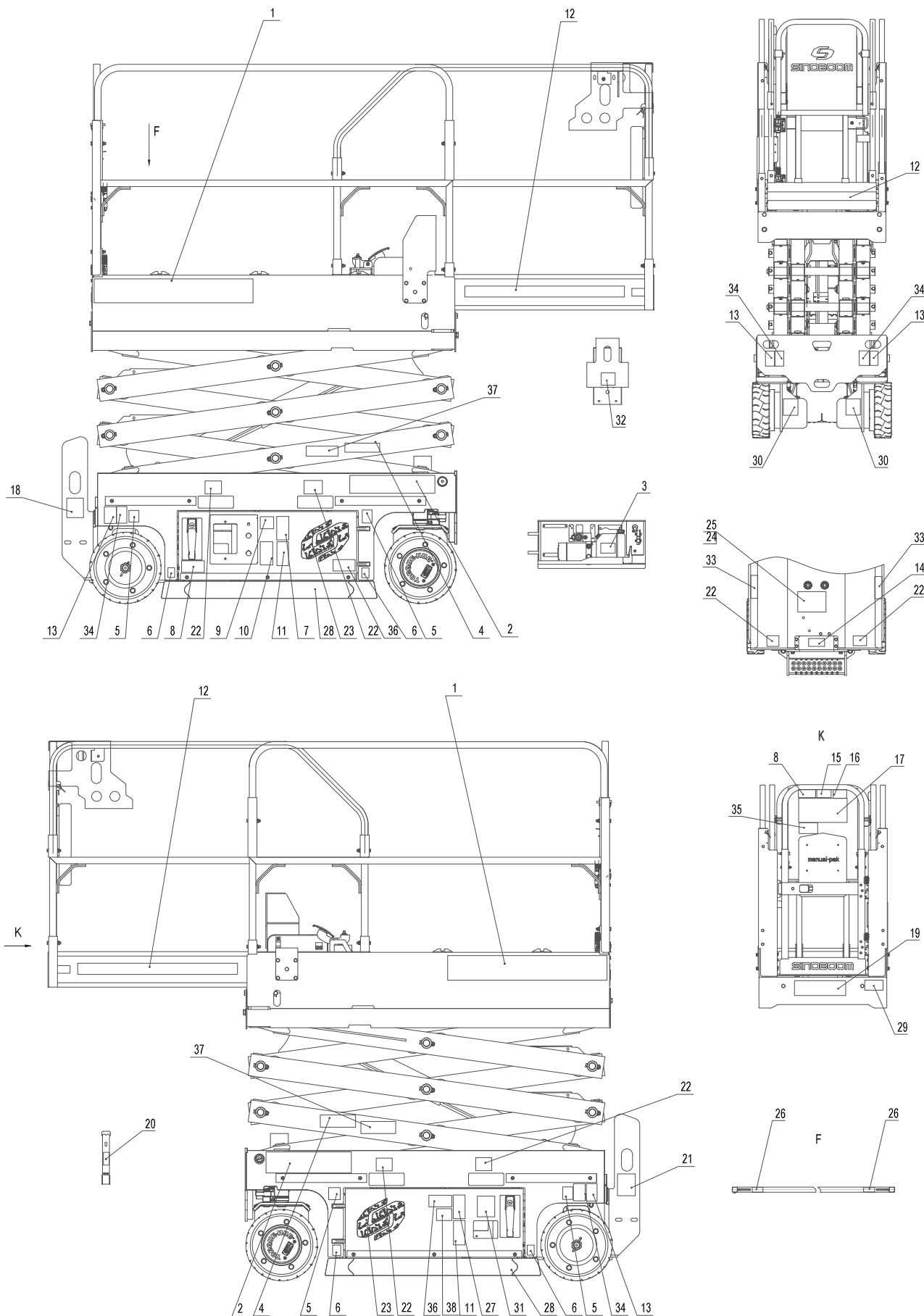
Do not operate machines without decals/nameplates.

|  <b>WARNING</b> |   |
|--|---|
|                 | <b>UNSAFE OPERATION HAZARD</b><br><b>All safety labels must be legible to alert personnel of safety hazards. Replace any illegible or missing labels immediately. Safety labels removed during any repair work must be replaced in their original position before the engine is placed back into service. Do not operate the engine if there are missing or badly worn safety labels.</b> |

## GTJZ0408SE&amp;0608SE&amp;0408ME&amp;0608ME DECALS/NAMEPLATES(CE)

| NO. | Part NO.     | Description                         | Qty | Remarks |
|-----|--------------|-------------------------------------|-----|---------|
|     | 101055000014 | Decals-GTJZ0408SE(CE)               | 1   |         |
|     | 101058000004 | Decals-GTJZ0608SE(CE)               | 1   |         |
|     | 101055000004 | Decals-GTJZ0408ME(CE)               | 1   |         |
|     | 101056000004 | Decals-GTJZ0408ME(CE)               | 1   |         |
| 1   | 101046100009 | Decal-sinoboom                      | 2   |         |
| 2   | 101055000016 | Decal-GTJZ0408SE                    | 2   |         |
|     | 101058000006 | Decal-GTJZ0608SE                    | 2   |         |
|     | 101055000006 | Decal-GTJZ0408ME                    | 2   |         |
|     | 101056000006 | Decal-GTJZ0608ME                    | 2   |         |
| 3   | 101014100022 | Decal-Oil filling port              | 1   |         |
| 4   | 101012100018 | Decal-Crush hazard                  | 2   |         |
| 5   | 101012100013 | Decal-Tire to ground max.load 550kg | 4   |         |
| 6   | 101012100020 | Decal-Crush hazard                  | 4   |         |
| 7   | 101038100002 | Decal-High-pressure fluids hazard   | 1   |         |
| 8   | 101012100005 | Decal-Electrocution hazard          | 2   |         |
| 9   | 101014100018 | Decal-Platform up/down button       | 1   |         |
| 10  | 101014100017 | Decal-Read manuals                  | 1   |         |
| 11  | 101038100008 | Decal-No firework                   | 2   |         |
| 12  | 216060000004 | Attention line, 50mm wide           | 4   |         |
| 13  | 101014100020 | Decal-Lifting lugs                  | 4   |         |
| 14  | 101012100011 | Decal-Emergency down                | 1   |         |
| 15  | 101040100005 | Decal-Read manuals                  | 1   |         |
| 16  | 101040100009 | Decal-Tipping hazard                | 1   |         |
| 17  | 101055000018 | Decal-Use condition(GTJZ0408SE)     | 1   |         |
|     | 101058000008 | Decal-Use condition(GTJZ0608SE)     | 1   |         |
|     | 101055000008 | Decal-Use condition(GTJZ0408ME)     | 1   |         |
|     | 101056000008 | Decal-Use condition(GTJZ0608ME)     | 1   |         |
| 18  | 101014100007 | Decal-Platform electrical plug      | 1   |         |
| 19  | 101055000017 | Decal-Use condition(GTJZ0408SE)     | 1   |         |
|     | 101058000007 | Decal-Use condition(GTJZ0608SE)     | 1   |         |
|     | 101055000007 | Decal-Use condition(GTJZ0408ME)     | 1   |         |
|     | 101056000007 | Decal-Use condition(GTJZ0608ME)     | 1   |         |
| 20  | 101040100010 | Decal-Engage the safety arm         | 1   |         |
| 21  | 101014100008 | Decal-Charging voltage              | 1   |         |

| NO. | Part NO.     | Description                        | Qty | Remarks |
|-----|--------------|------------------------------------|-----|---------|
| 22  | 101012100026 | Decal-Forklift fork position       | 6   |         |
| 23  | 101040100012 | Logo, white                        | 2   |         |
| 24  | 215050000012 | Blind rivet 4×8-ZnD GB/T 12618.2   | 4   |         |
| 25  | 101012100037 | Nameplate-CE                       | 1   |         |
| 26  | 101016100030 | Decal-Lanyard anchorage points     | 4   |         |
| 27  | 101038100007 | Decal-Electrocution hazard         | 1   |         |
| 28  | 216060000003 | Attention line, 100mm wide         | 3   |         |
| 29  | 101058103001 | Decal-IPAF                         | 1   |         |
| 30  | 101040103008 | Decal-Release brake                | 2   |         |
| 31  | 101055103018 | Decal-Main power switch            | 1   |         |
| 32  | 101055103015 | Decal-Emergency stop switch        | 1   |         |
| 33  | 101014100032 | Decal-Serial number                | 2   |         |
| 34  | 101014100021 | Decal-Tiedown                      | 4   |         |
| 35  | 101012100019 | Decal-Tipping hazard               | 1   |         |
| 36  | 101012100008 | Decal-Tipping hazard               | 2   |         |
| 37  | 101012100029 | Decal-Crush hazard                 | 2   |         |
| 38  | 101041103020 | Decal-Battery weight 120kg(265 lb) | 1   |         |

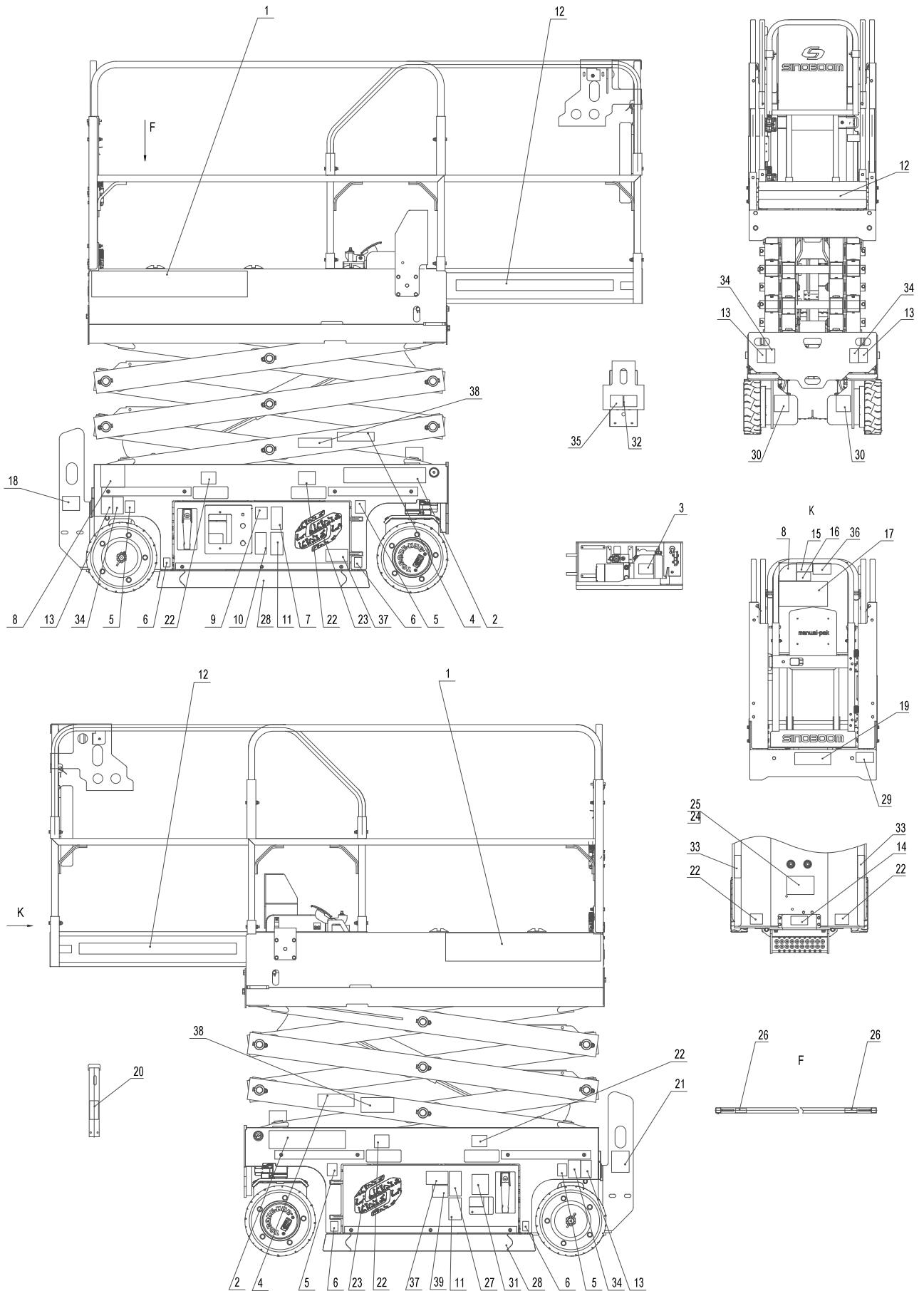




## GTJZ0408SE&0608SE&0408ME&0608ME DECALS/NAMEPLATES(AS)

| NO. | Part NO.     | Description                         | Qty | Remarks |
|-----|--------------|-------------------------------------|-----|---------|
|     | 101055000015 | Decals-GTJZ0408SE(AS)               | 1   |         |
|     | 101058000005 | Decals-GTJZ0608SE(AS)               | 1   |         |
|     | 101055000005 | Decals-GTJZ0408ME(AS)               | 1   |         |
|     | 101056000005 | Decals-GTJZ0608ME(AS)               | 1   |         |
| 1   | 101046100009 | Decal-sinoboom                      | 2   |         |
| 2   | 101055000016 | Decal-GTJZ0408SE                    | 2   |         |
|     | 101058000006 | Decal-GTJZ0608SE                    | 2   |         |
|     | 101055000006 | Decal-GTJZ0408ME                    | 2   |         |
|     | 101056000006 | Decal-GTJZ0608ME                    | 2   |         |
| 3   | 101014100022 | Decal-Oil filling port              | 1   |         |
| 4   | 101012100018 | Decal-Crush hazard                  | 2   |         |
| 5   | 101012100013 | Decal-Tire to ground max.load 550kg | 4   |         |
| 6   | 101012100020 | Decal-Crush hazard                  | 4   |         |
| 7   | 101038100002 | Decal-High-pressure fluids hazard   | 1   |         |
| 8   | 101055103019 | Decal-Keep away telegraph pole      | 2   |         |
| 9   | 101014100018 | Decal-Platform up/down button       | 1   |         |
| 10  | 101014100017 | Decal-Read manuals                  | 1   |         |
| 11  | 101038100008 | Decal-No firework                   | 2   |         |
| 12  | 216060000004 | Attention line, 50mm wide           | 4   |         |
| 13  | 101014100020 | Decal-Lifting lugs                  | 4   |         |
| 14  | 101012100011 | Decal-Emergency down                | 1   |         |
| 15  | 101040100005 | Decal-Read manuals                  | 1   |         |
| 16  | 101040100009 | Decal-Tipping hazard                | 1   |         |
| 17  | 101055000018 | Decal-Use condition(GTJZ0408SE)     | 1   |         |
|     | 101058000008 | Decal-Use condition(GTJZ0608SE)     | 1   |         |
|     | 101055000008 | Decal-Use condition(GTJZ0408ME)     | 1   |         |
|     | 101056000008 | Decal-Use condition(GTJZ0608ME)     | 1   |         |
| 18  | 101014100007 | Decal-Platform electrical plug      | 1   |         |
| 19  | 101055000019 | Decal-Use condition(GTJZ0408SE)     | 1   |         |
|     | 101058000009 | Decal-Use condition(GTJZ0608SE)     | 1   |         |
|     | 101055000009 | Decal-Use condition(GTJZ0408ME)     | 1   |         |
|     | 101056000009 | Decal-Use condition(GTJZ0608ME)     | 1   |         |
| 20  | 101014100026 | Decal-Crush hazard                  | 1   |         |
| 21  | 101014100008 | Decal-Charging voltage              | 1   |         |

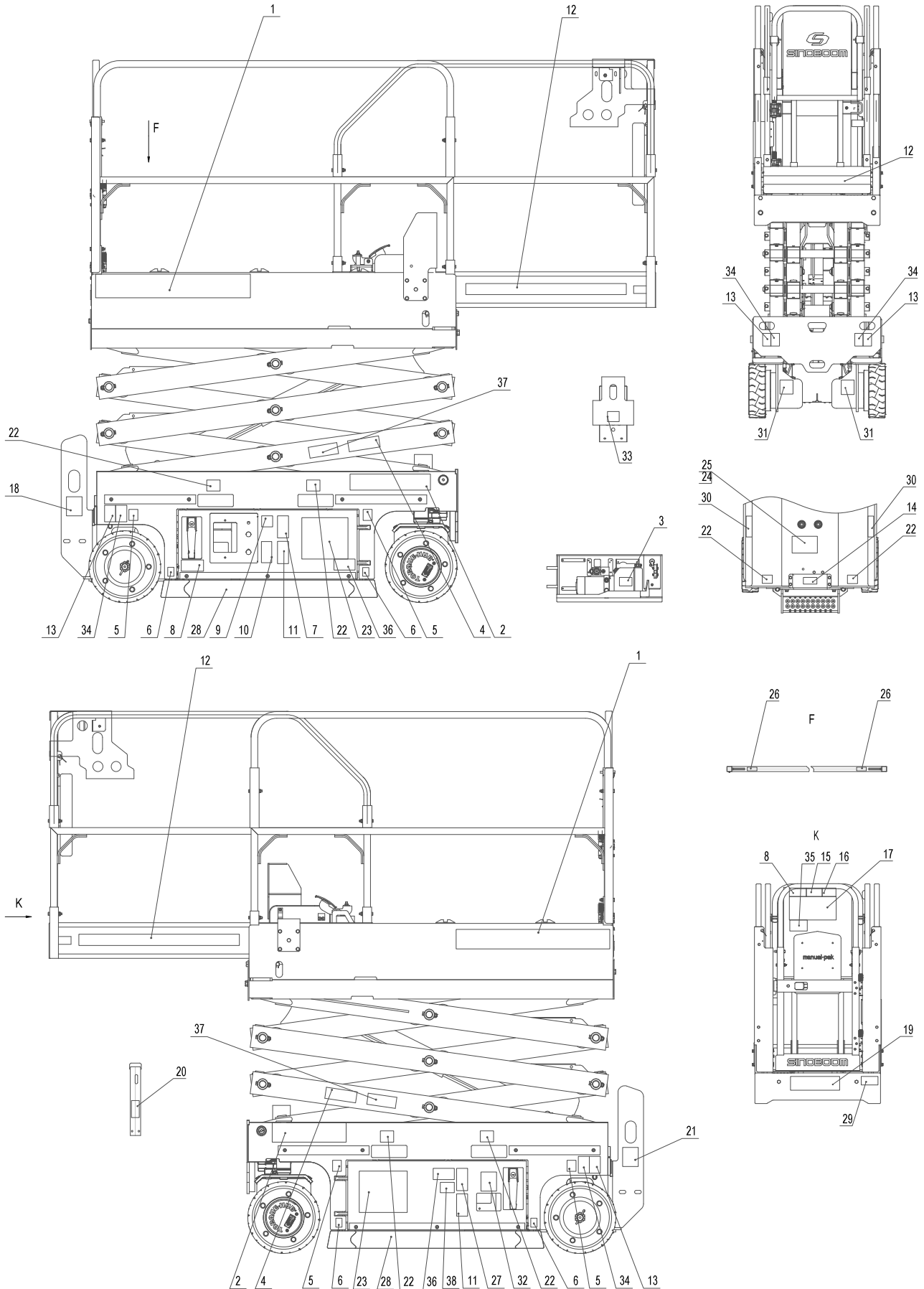
| NO. | Part NO.     | Description                        | Qty | Remarks |
|-----|--------------|------------------------------------|-----|---------|
| 22  | 101012100026 | Decal-Forklift fork position       | 6   |         |
| 23  | 101040100012 | Logo, white                        | 2   |         |
| 24  | 215050000012 | Blind rivet 4×8-ZnD GB/T 12618.2   | 4   |         |
| 25  | 101012100038 | Nameplate-AS                       | 1   |         |
| 26  | 101016100030 | Decal-Lanyard anchorage points     | 4   |         |
| 27  | 101038100007 | Decal-Read manuals                 | 1   |         |
| 28  | 216060000003 | Attention line, 100mm wide         | 3   |         |
| 29  | 101058103001 | Decal-IPAF                         | 1   |         |
| 30  | 101040103008 | Decal-Release brake                | 2   |         |
| 31  | 101055103018 | Decal-Emergency stop handle        | 1   |         |
| 32  | 101055103015 | Decal-Emergency stop switch        | 1   |         |
| 33  | 101014100032 | Decal-Serial number                | 2   |         |
| 34  | 101014100021 | Decal-Tiedown                      | 4   |         |
| 35  | 101040103014 | Decal-Detachable bracket           | 1   |         |
| 36  | 101012100019 | Decal-Tipping hazard               | 1   |         |
| 37  | 101012100008 | Decal-Tipping hazard               | 2   |         |
| 38  | 101012100029 | Decal-Crush hazard                 | 2   |         |
| 39  | 101041103020 | Decal-Battery weight 120kg(265 lb) | 1   |         |



## GTJZ0408SE&amp;0608SE&amp;0408ME&amp;0608ME DECALS/NAMEPLATES(KCS)

| NO. | Part NO.     | Description                         | Qty | Remarks |
|-----|--------------|-------------------------------------|-----|---------|
|     | 101057103004 | Decals-GTJZ0408SE(KCS)              | 1   |         |
|     | 101058103005 | Decals-GTJZ0608SE(KCS)              | 1   |         |
|     | 101055103003 | Decals-GTJZ0408ME(KCS)              | 1   |         |
|     | 101056103003 | Decals-GTJZ0608ME(KCS)              | 1   |         |
| 1   | 101046100009 | Decal-sinoboom                      | 2   |         |
| 2   | 101055000016 | Decal-GTJZ0408SE                    | 2   |         |
|     | 101058000006 | Decal-GTJZ0608SE                    | 2   |         |
|     | 101055000006 | Decal-GTJZ0408ME                    | 2   |         |
|     | 101056000006 | Decal-GTJZ0608ME                    | 2   |         |
| 3   | 101014100022 | Decal-Oil filling port              | 1   |         |
| 4   | 101012100018 | Decal-Crush hazard                  | 2   |         |
| 5   | 101012100013 | Decal-Tire to ground max.load 550kg | 4   |         |
| 6   | 101012100020 | Decal-Crush hazard                  | 4   |         |
| 7   | 101038100002 | Decal-High-pressure fluids hazard   | 1   |         |
| 8   | 101012100005 | Decal-Electrocution hazard          | 2   |         |
| 9   | 101014100018 | Decal-Platform up/down button       | 1   |         |
| 10  | 101014100017 | Decal-Read manuals                  | 1   |         |
| 11  | 101038100008 | Decal-No firework                   | 2   |         |
| 12  | 216060000004 | Attention line, 50mm wide           | 4   |         |
| 13  | 101014100020 | Decal-Lifting lugs                  | 4   |         |
| 14  | 101012100011 | Decal-Emergency down                | 1   |         |
| 15  | 101040100005 | Decal-Read manuals                  | 1   |         |
| 16  | 101040100009 | Decal-Tipping hazard                | 1   |         |
| 17  | 101055000018 | Decal-Use condition(GTJZ0408SE)     | 1   |         |
|     | 101058000008 | Decal-Use condition(GTJZ0608SE)     | 1   |         |
|     | 101055000008 | Decal-Use condition(GTJZ0408ME)     | 1   |         |
|     | 101056000008 | Decal-Use condition(GTJZ0608ME)     | 1   |         |
| 18  | 101014100007 | Decal-Platform electrical plug      | 1   |         |
| 19  | 101055000017 | Decal-Use condition(GTJZ0408SE)     | 1   |         |
|     | 101058000007 | Decal-Use condition(GTJZ0608SE)     | 1   |         |
|     | 101055000007 | Decal-Use condition(GTJZ0408ME)     | 1   |         |
|     | 101056000007 | Decal-Use condition(GTJZ0608ME)     | 1   |         |
| 20  | 101014100026 | Decal-Crush hazard                  | 1   |         |
| 21  | 101014100008 | Decal-Charging voltage              | 1   |         |

| NO. | Part NO.     | Description                        | Qty | Remarks |
|-----|--------------|------------------------------------|-----|---------|
| 22  | 101012100026 | Decal-Forklift fork position       | 6   |         |
| 23  | 101040100012 | Logo, white                        | 2   |         |
| 24  | 215050000012 | Blind rivet 4×8-ZnD GB/T 12618.2   | 4   |         |
| 25  | 101015100026 | Nameplate (KCS)                    | 1   |         |
| 26  | 101016100030 | Decal-Lanyard anchorage points     | 4   |         |
| 27  | 101038100007 | Decal-Read manuals                 | 1   |         |
| 28  | 216060000003 | Attention line, 100mm wide         | 3   |         |
| 29  | 101058103001 | Decal-IPAF                         | 1   |         |
| 30  | 101014100032 | Decal-Serial number                | 2   |         |
| 31  | 101040103008 | Decal-Release brake                | 2   |         |
| 32  | 101055103018 | Decal-Emergency stop handle        | 1   |         |
| 33  | 101055103015 | Decal-Emergency stop switch        | 1   |         |
| 34  | 101014100021 | Decal-Tiedown                      | 4   |         |
| 35  | 101012100019 | Decal-Tipping hazard               | 1   |         |
| 36  | 101012100008 | Decal-Tipping hazard               | 2   |         |
| 37  | 101012100029 | Decal-Crush hazard                 | 2   |         |
| 38  | 101041103020 | Decal-Battery weight 120kg(265 lb) | 1   |         |

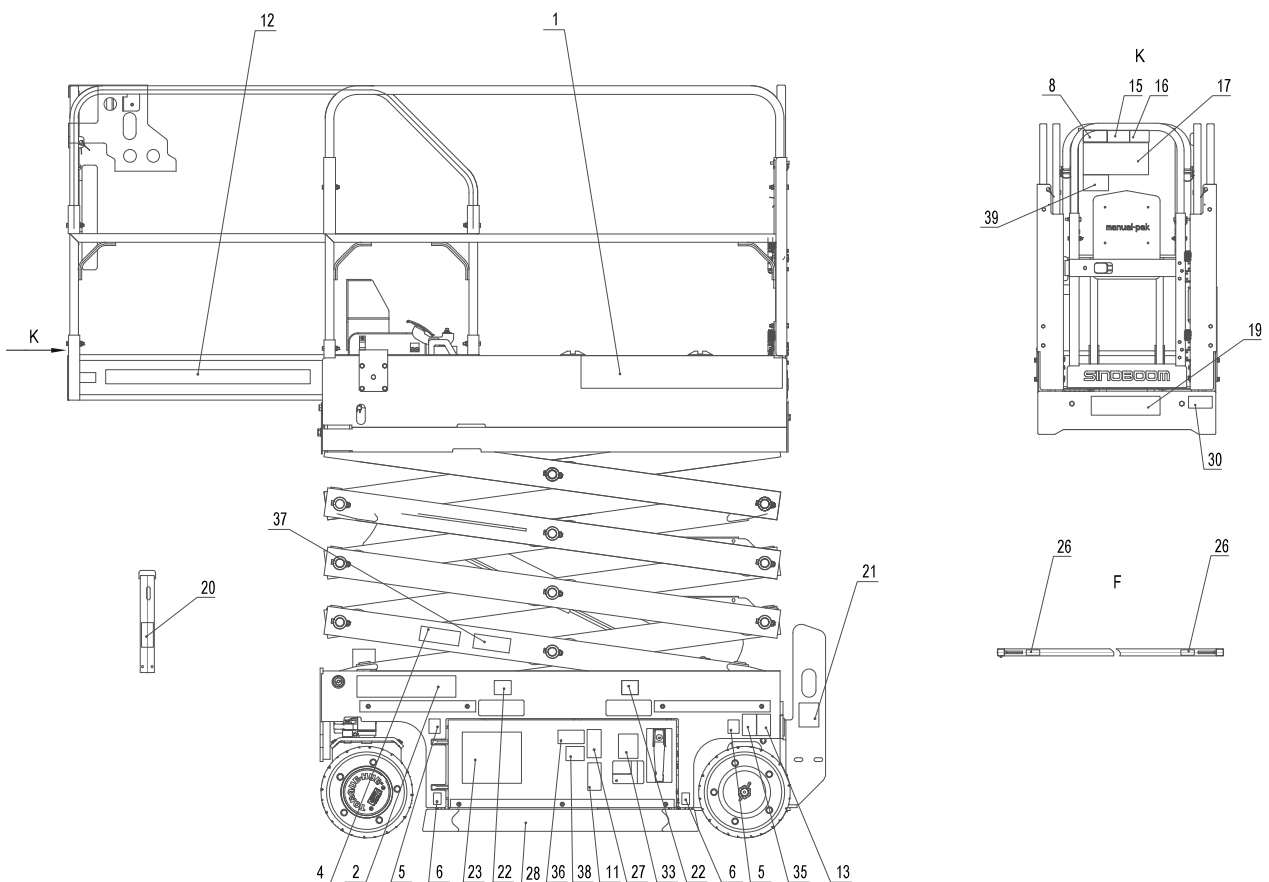
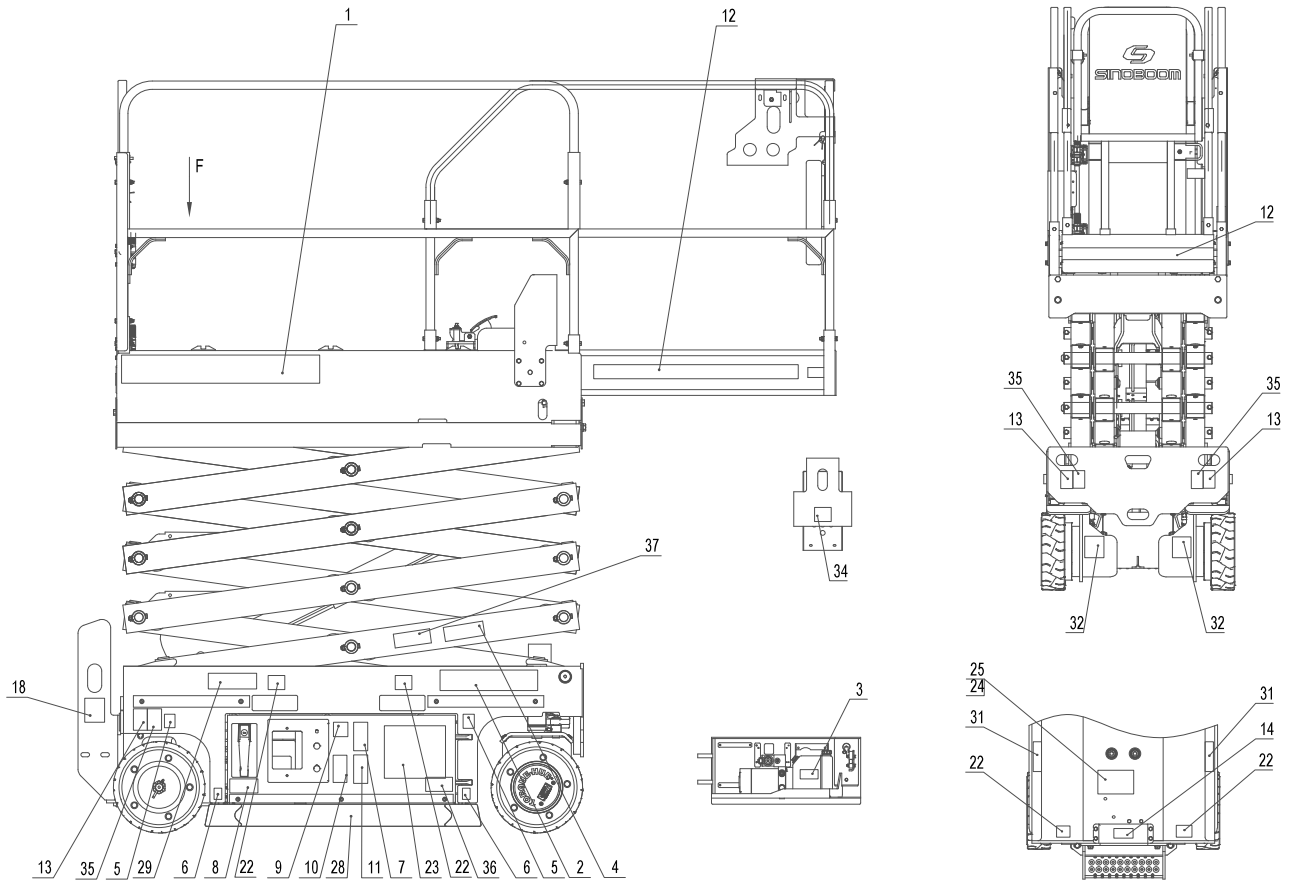


## GTJZ0408SE&0608SE&0408ME&0608ME DECALS/NAMEPLATES(CE-PL)

| NO. | Part NO.     | Description                       | Qty | Remarks |
|-----|--------------|-----------------------------------|-----|---------|
|     | 101057103005 | Decals-GTJZ0408SE(CE-PL)          | 1   |         |
|     | 101058103006 | Decals-GTJZ0608SE(CE-PL)          | 1   |         |
|     | 101055103004 | Decals-GTJZ0408ME(CE-PL)          | 1   |         |
|     | 101056103004 | Decals-GTJZ0608ME(CE-PL)          | 1   |         |
| 1   | 101046100009 | Decal-sinoboom                    | 2   |         |
| 2   | 101055000016 | Decal-GTJZ0408SE                  | 2   |         |
|     | 101058000006 | Decal-GTJZ0608SE                  | 2   |         |
|     | 101055000006 | Decal-GTJZ0408ME                  | 2   |         |
|     | 101056000006 | Decal-GTJZ0608ME                  | 2   |         |
| 3   | 101014100022 | Decal-Oil filling port            | 1   |         |
| 4   | 101012100018 | Decal-Crush hazard                | 2   |         |
| 5   | 101057103007 | Decal-Wheel maximum load 550Kg    | 4   |         |
| 6   | 101012100020 | Decal-Crush hazard                | 4   |         |
| 7   | 101038100002 | Decal-High-pressure fluids hazard | 1   |         |
| 8   | 101012100005 | Decal-Electrocution hazard        | 2   |         |
| 9   | 101014100018 | Decal-Platform up/down button     | 1   |         |
| 10  | 101014100017 | Decal-Read manuals                | 1   |         |
| 11  | 101038100008 | Decal-No firework                 | 2   |         |
| 12  | 216060000004 | Attention line, 50mm wide         | 4   |         |
| 13  | 101014100020 | Decal-Lifting lugs                | 4   |         |
| 14  | 101012100011 | Decal-Emergency down              | 1   |         |
| 15  | 101040100005 | Decal-Read manuals                | 1   |         |
| 16  | 101040100009 | Decal-Tipping hazard              | 1   |         |
| 17  | 101055000018 | Decal-Use condition(GTJZ0408SE)   | 1   |         |
|     | 101058000008 | Decal-Use condition(GTJZ0608SE)   | 1   |         |
|     | 101055000008 | Decal-Use condition(GTJZ0408ME)   | 1   |         |
|     | 101056000008 | Decal-Use condition(GTJZ0608ME)   | 1   |         |
| 18  | 101014100007 | Decal-Platform electrical plug    | 1   |         |
| 19  | 101055000017 | Decal-Use condition(GTJZ0408SE)   | 1   |         |
|     | 101058000007 | Decal-Use condition(GTJZ0608SE)   | 1   |         |
|     | 101055000007 | Decal-Use condition(GTJZ0408ME)   | 1   |         |
|     | 101056000007 | Decal-Use condition(GTJZ0608ME)   | 1   |         |
| 20  | 101014100026 | Decal-Crush hazard                | 1   |         |
| 21  | 101014100008 | Decal-Charging voltage            | 1   |         |

| NO. | Part NO.     | Description                        | Qty | Remarks |
|-----|--------------|------------------------------------|-----|---------|
| 22  | 101012100026 | Decal-Forklift fork position       | 6   |         |
| 23  | 101040100012 | Logo, white                        | 2   |         |
| 24  | 215050000012 | Blind rivet 4×8-ZnD GB/T 12618.2   | 4   |         |
| 25  | 101012100037 | Nameplate (CE)                     | 1   |         |
| 26  | 101016100030 | Decal-Lanyard anchorage points     | 4   |         |
| 27  | 101038100007 | Decal-Read manuals                 | 1   |         |
| 28  | 216060000003 | Attention line, 100mm wide         | 3   |         |
| 29  | 101058103000 | Q-LINE(Logo)                       | 1   |         |
| 30  | 101058103001 | Decal-IPAF                         | 1   |         |
| 31  | 101014100032 | Decal-Serial number                | 2   |         |
| 32  | 101040103008 | Decal-Release brake                | 2   |         |
| 33  | 101055103018 | Decal-Emergency stop handle        | 1   |         |
| 34  | 101055103015 | Decal-Emergency stop switch        | 1   |         |
| 35  | 101014100032 | Decal-Serial number                | 2   |         |
| 36  | 101012100019 | Decal-Tipping hazard               | 1   |         |
| 37  | 101012100008 | Decal-Tipping hazard               | 2   |         |
| 38  | 101012100029 | Decal-Crush hazard                 | 2   |         |
| 39  | 101041103020 | Decal-Battery weight 120kg(265 lb) | 1   |         |

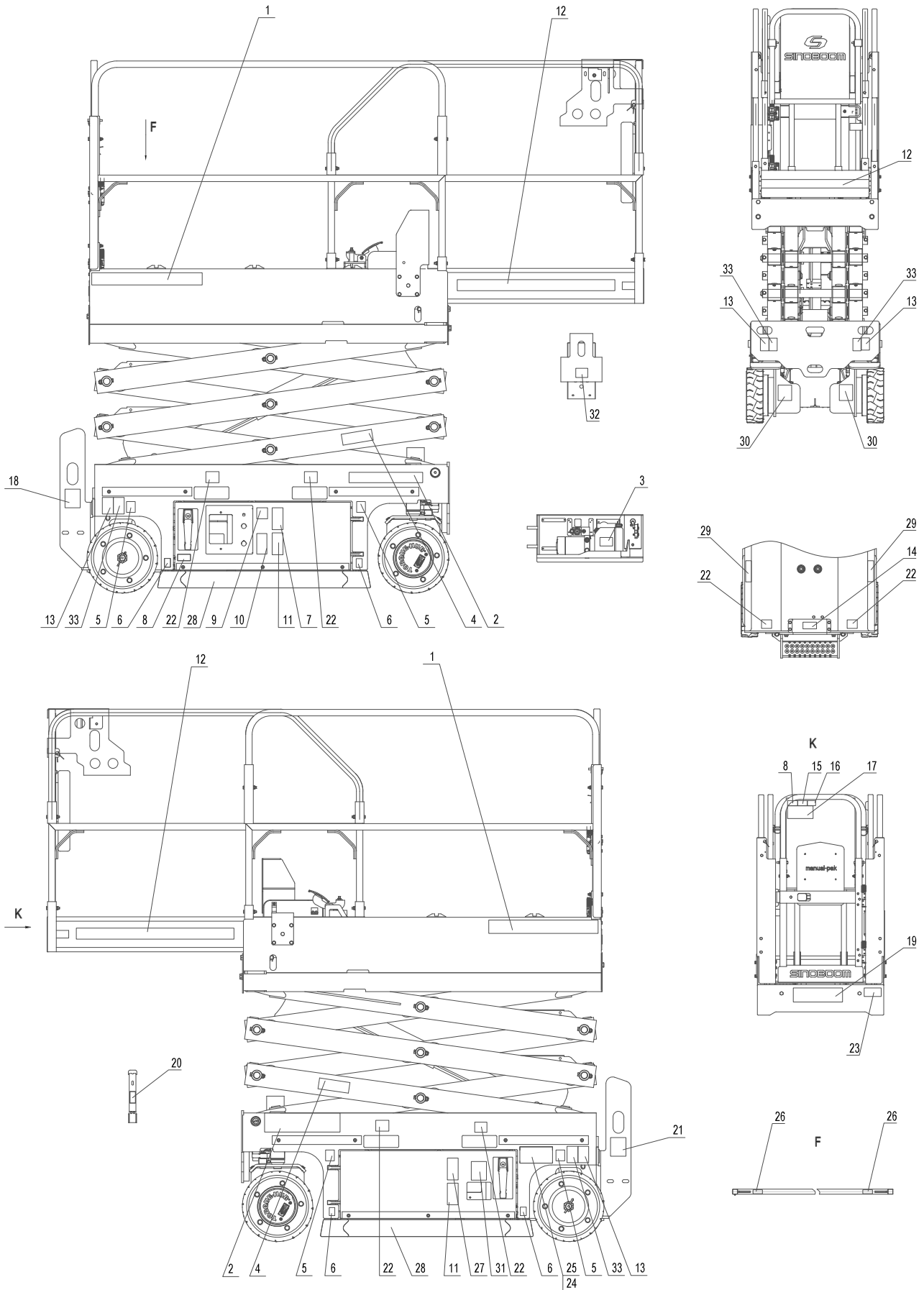




## GTJZ0408SE&amp;0608SE&amp;0408ME&amp;0608ME DECALS/NAMEPLATES(JP)

| NO. | Part NO.     | Description                         | Qty | Remarks |
|-----|--------------|-------------------------------------|-----|---------|
|     | 101057103006 | Decals-GTJZ0408SE(JP)               | 1   |         |
|     | 101058103007 | Decals-GTJZ0608SE(JP)               | 1   |         |
|     | 101055103005 | Decals-GTJZ0408ME(JP)               | 1   |         |
|     | 101056103005 | Decals-GTJZ0408ME(JP)               | 1   |         |
| 1   | 101053103004 | Decal-sinoboom                      | 2   |         |
| 2   | 101055000016 | Decal-GTJZ0408SE                    | 2   |         |
|     | 101058000006 | Decal-GTJZ0608SE                    | 2   |         |
|     | 101055000006 | Decal-GTJZ0408ME                    | 2   |         |
|     | 101056000006 | Decal-GTJZ0608ME                    | 2   |         |
| 3   | 101014100022 | Decal-Oil filling port              | 1   |         |
| 4   | 101012100018 | Decal-Crush hazard                  | 2   |         |
| 5   | 101012100013 | Decal-Tire to ground max.load 550kg | 4   |         |
| 6   | 101012100020 | Decal-Crush hazard                  | 4   |         |
| 7   | 101038100002 | Decal-High-pressure fluids hazard   | 1   |         |
| 8   | 101053103005 | Decal-Keep away telegraph pole      | 2   |         |
| 9   | 101014100018 | Decal-Platform up/down button       | 1   |         |
| 10  | 101014100017 | Decal-Read manuals                  | 1   |         |
| 11  | 101038100008 | Decal-No firework                   | 2   |         |
| 12  | 216060000004 | Attention line, 50mm wide           | 4   |         |
| 13  | 101014100020 | Decal-Lifting lugs                  | 4   |         |
| 14  | 101012100011 | Decal-Emergency down                | 1   |         |
| 15  | 101054103001 | Decal-Read manuals                  | 1   |         |
| 16  | 101054103002 | Decal-Tipping hazard                | 1   |         |
| 17  | 101057103001 | Decal-Use condition(GTJZ0408SE)     | 1   |         |
|     | 101058103002 | Decal-Use condition(GTJZ0608SE)     | 1   |         |
|     | 101055103001 | Decal-Use condition(GTJZ0408ME)     | 1   |         |
|     | 101056103000 | Decal-Use condition(GTJZ0608ME)     | 1   |         |
| 18  | 101014100007 | Decal-Platform electrical plug      | 1   |         |
| 19  | 101055000017 | Decal-Use condition(GTJZ0408SE)     | 1   |         |
|     | 101058000007 | Decal-Use condition(GTJZ0608SE)     | 1   |         |
|     | 101055000007 | Decal-Use condition(GTJZ0408ME)     | 1   |         |
|     | 101056000007 | Decal-Use condition(GTJZ0608ME)     | 1   |         |
| 20  | 101040100010 | Decal-Engage the safety arm         | 1   |         |
| 21  | 101014100008 | Decal-Charging voltage              | 1   |         |

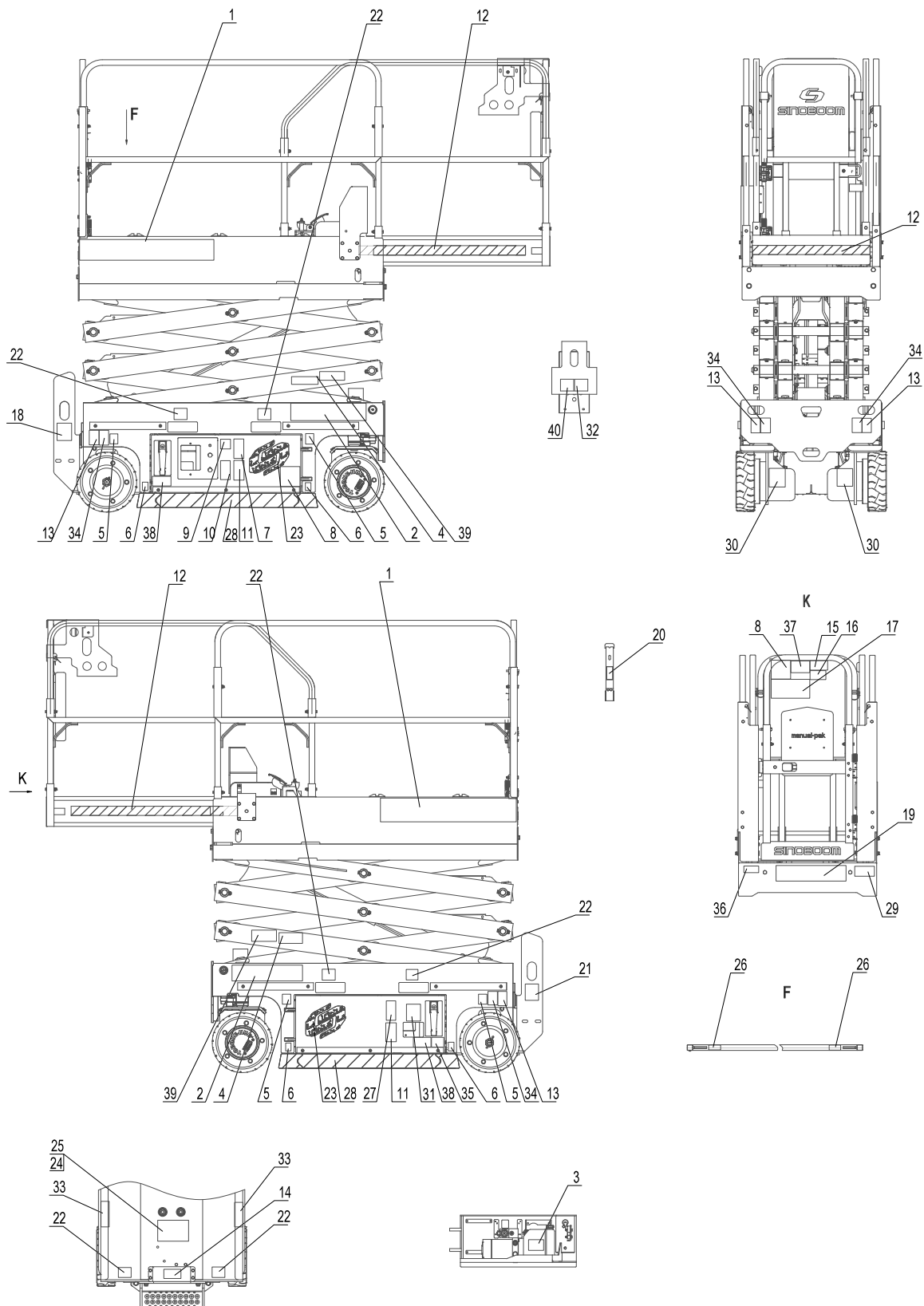
| NO. | Part NO.     | Description                      | Qty | Remarks |
|-----|--------------|----------------------------------|-----|---------|
| 22  | 101012100026 | Decal-Forklift fork position     | 6   |         |
| 23  | 101058103001 | Decal-IPAF                       | 1   |         |
| 24  | 215050000001 | Blind rivet 4×8-ZnD GB/T 12618.2 | 4   |         |
| 25  | 101055103002 | Nameplate-CE                     | 1   |         |
| 26  | 101016100030 | Decal-Lanyard anchorage points   | 4   |         |
| 27  | 101038100007 | Decal-Read manuals               | 1   |         |
| 28  | 216060000003 | Attention line, 100mm wide       | 3   |         |
| 29  | 101014100032 | Decal-Serial number              | 2   |         |
| 30  | 101040103008 | Decal-Release brake              | 2   |         |
| 31  | 101055103018 | Decal-Emergency stop handle      | 1   |         |
| 32  | 101055103015 | Decal-Emergency stop switch      | 1   |         |
| 33  | 101014100021 | Decal-Lanyard anchorage points   | 4   |         |



**GTJZ0408SE&0608SE&0408ME&0608ME DECALS/NAMEPLATES(ANSI)**

| NO. | Part NO.     | Description                         | Qty | Remarks |
|-----|--------------|-------------------------------------|-----|---------|
|     | 101057103016 | Decals-GTJZ0408SE(ANSI)             | 1   |         |
|     | 101058103010 | Decals-GTJZ0608SE(ANSI)             | 1   |         |
|     | 101055103021 | Decals-GTJZ0408ME(ANSI)             | 1   |         |
|     | 101056103015 | Decals-GTJZ0608ME(ANSI)             | 1   |         |
| 1   | 101046100009 | Decal-SINOBOOM                      | 2   |         |
| 2   | 101055000016 | Decal-GTJZ0408SE                    | 2   |         |
|     | 101058000006 | Decal-GTJZ0608SE                    | 2   |         |
|     | 101055000006 | Decal-GTJZ0408ME                    | 2   |         |
|     | 101056000006 | Decal-GTJZ0608ME                    | 2   |         |
| 3   | 101014100022 | Decal-Oil filling port              | 1   |         |
| 4   | 101012100018 | Decal-Crush hazard                  | 2   |         |
| 5   | 101036103002 | Decal-Tire to ground max.load 550kg | 4   |         |
| 6   | 101012100020 | Decal-Crush hazard                  | 4   |         |
| 7   | 101038100002 | Decal-High-pressure fluids hazard   | 1   |         |
| 8   | 101040103013 | Decal-Electrocution hazard          | 2   |         |
| 9   | 101014100018 | Decal-Platform up/down button       | 1   |         |
| 10  | 101014100017 | Decal-Read manuals                  | 1   |         |
| 11  | 101038100008 | Decal-No firework                   | 2   |         |
| 12  | 216060000004 | Attention line, 50mm wide           | 4   |         |
| 13  | 101014100020 | Decal-Lifting lugs                  | 4   |         |
| 14  | 101012100011 | Decal-Emergency down                | 1   |         |
| 15  | 101040100005 | Decal-Read manuals                  | 1   |         |
| 16  | 101040100009 | Decal-Tipping hazard                | 1   |         |
| 17  | 101057103017 | Decal-Use condition(GTJZ0408SE)     | 1   |         |
|     | 101058103011 | Decal-Use condition(GTJZ0608SE)     | 1   |         |
|     | 101055103022 | Decal-Use condition(GTJZ0408ME)     | 1   |         |
|     | 101056103016 | Decal-Use condition(GTJZ0608ME)     | 1   |         |
| 18  | 101014100007 | Decal-Platform electrical plug      | 1   |         |
| 19  | 101057103018 | Decal-Use condition(GTJZ0408SE)     | 1   |         |
|     | 101058103012 | Decal-Use condition(GTJZ0608SE)     | 1   |         |
|     | 101055103023 | Decal-Use condition(GTJZ0408ME)     | 1   |         |
|     | 101056103017 | Decal-Use condition(GTJZ0608ME)     | 1   |         |
| 20  | 101040100010 | Decal-Engage the safety arm         | 1   |         |
| 21  | 101014100008 | Decal-Charging voltage              | 1   |         |

| NO. | Part NO.     | Description                        | Qty | Remarks |
|-----|--------------|------------------------------------|-----|---------|
| 22  | 101012100026 | Decal-Forklift fork position       | 6   |         |
| 23  | 101040100012 | Logo, white                        | 2   |         |
| 24  | 215050000012 | Blind rivet 4×8-ZnD GB/T 12618.2   | 4   |         |
| 25  | 101048103010 | Nameplate-ANSI                     | 1   |         |
| 26  | 101016100030 | Decal-Lanyard anchorage points     | 4   |         |
| 27  | 101038100007 | Decal-Read manuals                 | 1   |         |
| 28  | 216060000003 | Attention line, 100mm wide         | 3   |         |
| 29  | 101058103001 | Decal-IPAF                         | 1   |         |
| 30  | 101040103008 | Decal-Release brake                | 2   |         |
| 31  | 101055103018 | Decal-Emergency stop handle        | 1   |         |
| 32  | 101055103015 | Decal-Emergency stop switch        | 1   |         |
| 33  | 101014100032 | Decal-Serial number                | 2   |         |
| 34  | 101014100021 | Decal-Tiedown                      | 4   |         |
| 35  | 101055103024 | Decal-Battery weight 120kg(265 lb) | 1   |         |
| 36  | 101040103015 | Decal-Annual inspection            | 1   |         |
| 37  | 101012100019 | Decal-Tipping hazard               | 1   |         |
| 38  | 101012100008 | Decal-Tipping hazard               | 2   |         |
| 39  | 101012100029 | Decal-Crush hazard                 | 2   |         |
| 40  | 101040103014 | Decal-Detachable bracket           | 1   |         |



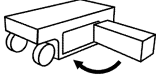

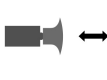







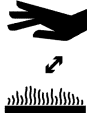
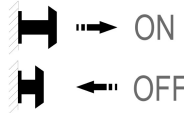
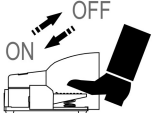
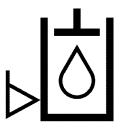
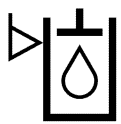


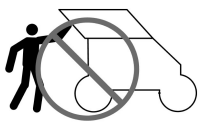





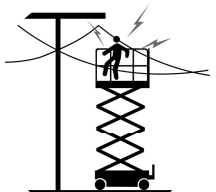

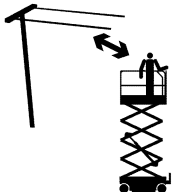
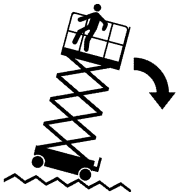
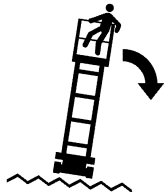


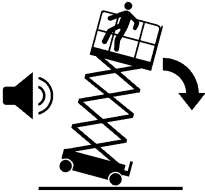
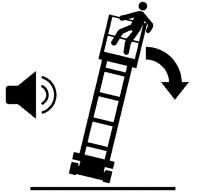
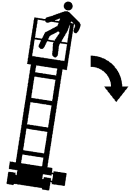



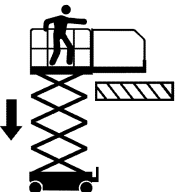

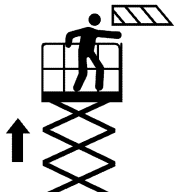
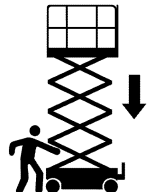


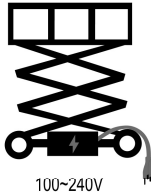

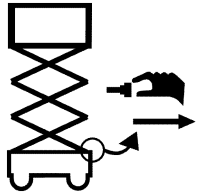
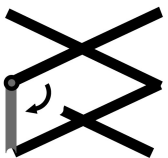
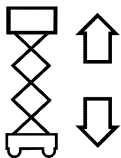
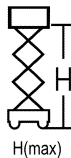
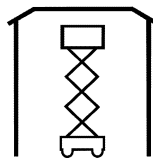
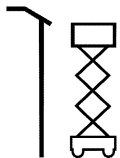






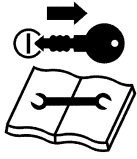

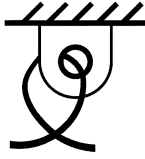

**This Page Intentionally Left Blank**











# APPENDIX 1: SYMBOLS AND DESCRIPTION

## SYMBOLS CHART

|   |   |   |  |   |
|---|---|---|--|---|
| <br>Read maintenance manual              | <br>Anchor point allows only 1 person to tie           | <br>Close the chassis door box                   | <br>Press the change valve                      | <br>Repeatedly move manual brake release valve                   |
| <br>Wind speed                           | <br>Chemical burns hazards                             | <br>Wedge the wheel                              | <br>Release the brake                           | <br>Wind   |
| <br>Noise level                         | <br>Burns hazards                                     | <br>Keep a safe distance from high temperatures | <br>Pull out-open<br>Press-close                | <br>Step-open<br>Release-close                                  |
| <br>Hydraulic oil level - low position | <br>Hydraulic oil level - high position              | <br>Temperature                                | <br>Change the tires of the same specification | <br>Only trained maintenance personnel can access the bulkhead |
| <br>Read operation manual              | <br>Add lubricant                                    | <br>Crushing hazard-<br>Please wear work shoes | <br>Danger of hot, high pressure fluids       | <br>Collision hazards-<br>Release brake on ramp                |
| <br>Electrocution hazards on platform  | <br>Electrocution hazards on the ground and platform | <br>Keep a safe distance from power lines      | <br>Tip-over hazards-Avoid uneven ground       | <br>Tip-over hazards-Avoid uneven ground                       |

|  |   |  |   |   |
|--|---|--|---|---|
|  <p>Tip-over hazards-<br/>Never use machine during strong, gusty wind</p>         |  <p>Tip-over hazards-<br/>Never use machine during strong, gusty wind</p>                          |  <p>Tip-over hazards-<br/>Never leave chassis door open</p>                                 |  <p>Tip-over hazards-<br/>Never push or pull objects outside platform</p>                |  <p>Tip-over hazards-<br/>Never suspend objects from platform</p>                      |
|  <p>Tip-over hazards-<br/>Never place ladders and scaffolding on the platform</p> |  <p>Collision hazards-<br/>Never lower extended platform without checking for nearby obstacles</p> |  <p>Collision hazards-<br/>Never raise platform without checking for overhead obstacles</p> |  <p>Crushing hazards-<br/>Keep hands away form nearby obstacles when raising platform</p> |  <p>Crushing hazards-<br/>Keep hands away form scissor arms when lowering platform</p> |
|  <p>Fall hazards-<br/>Never climb on guardrails of platform</p>                  |  <p>Fall hazards-<br/>Never climb on scissor arms</p>   |  <p>Battery charging plug</p>  |  <p>Platform power plug</p>  |  <p>Emergency lowering handle position</p>  |
|  <p>Open the safety arm</p>   |  <p>The platform moves up and down</p>   |  <p>Maximum height of platform</p>  |  <p>Indoor use</p>  |  <p>Outdoor use</p>  |
|  <p>The side force</p>  |  <p>Electrocution hazards</p>  |  <p>Wear protective clothing and glasses</p>  |  <p>Battery explosion hazard</p>   |  <p>No smoking</p>   |
|  <p>No smoking</p>  |  <p>Only professional maintenance personnel can start the maintenance</p>                        |  <p>Improve point</p>   |  <p>Lashing points</p>  |  <p>Tire to ground load</p>  |

|   |   |   |   |   |
|---|---|---|---|---|
|  <p>Forklift fork position</p> |  <p>Platform carrying capacity</p> |  <p>Carrying capacity of fixed and extended platform</p> |  <p>Hydraulic oil filler</p> |  <p>Horn</p> |
|  <p>Tool or weight</p>         |  <p>Fast/high speed</p>            |  <p>Slow/low speed</p>                                   |   |   |

**This Page Intentionally Left Blank**

# APPENDIX 2: PREPARE THE WORK RECORD BEFORE DELIVERY

| PREPARE THE WORK RECORD BEFORE DELIVERY  |                                  |                                      |                                    |
|--|----------------------------------|--------------------------------------|------------------------------------|
| Model  |                                  |                                      |                                    |
| Serial No.   |                                  |                                      |                                    |
| Inspection Item  | YES/Machine is in Good Condition | NO/Machine Has Damage or Malfunction | REPAIRED/Machine Has Been Repaired |
| Pre-operational Inspection   |                                  |                                      |                                    |
| Maintenance Procedure  |                                  |                                      |                                    |
| Functional Inspection  |                                  |                                      |                                    |
| Machine Buyer/ Renter  |                                  |                                      |                                    |
| Inspector Signature  |                                  |                                      |                                    |
| Inspector Title  |                                  |                                      |                                    |
| Inspector Company  |                                  |                                      |                                    |
| <p><b>NOTE:</b></p> <ol style="list-style-type: none"> <li>1. Prepare the machine before delivery, which includes performing a pre-delivery inspection, following maintenance procedures and performing functional inspections.</li> <li>2. Use the table to record the results. After each section is complete, mark the appropriate box.</li> <li>3. Record the inspection results. If any inspection results are "NO", the machine must be stopped and re-inspected after repair is completed and marked in the box marked "inspection".</li> </ol> |                                  |                                      |                                    |

**This Page Intentionally Left Blank**

# APPENDIX 3: REPAIR & INSPECTION REPORT

| REPAIR & INSPECTION REPORT                                       |                                  |                                      |                                    |                     |
|--|----------------------------------|--------------------------------------|------------------------------------|---------------------|
| Model  |                                  |                                      |                                    |                     |
| Serial No.   |                                  |                                      |                                    |                     |
| Checklist A Procedures   |                                  |                                      |                                    |                     |
| Items  | YES/Machine is in Good Condition | NO/Machine Has Damage or Malfunction | REPAIRED/Machine Has Been Repaired | Problem Description |
| A-1 Inspect All Manuals  |                                  |                                      |                                    |                     |
| A-2 Inspect All Decals   |                                  |                                      |                                    |                     |
| A-3 Inspect Damaged, Loose or Lost Parts                         |                                  |                                      |                                    |                     |
| A-4 Inspect Hydraulic Oil Level                                  |                                  |                                      |                                    |                     |
| A-5 Inspect Hydraulic Oil Leakage                                |                                  |                                      |                                    |                     |
| A-6 Functional Tests   |                                  |                                      |                                    |                     |
| A-7 Inspect Emergency Lowering Function                          |                                  |                                      |                                    |                     |
| A-8 Test Braking Device  |                                  |                                      |                                    |                     |
| A-9 Full Lifting and Full Lowering Time Test                     |                                  |                                      |                                    |                     |
| A-10 Testing Traveling Speed (Platform is Lifted State)          |                                  |                                      |                                    |                     |
| A-11 Testing Traveling Speed (Platform is Fully Retracted State) |                                  |                                      |                                    |                     |
| A-12 Inspect the Tilt Protection Function                        |                                  |                                      |                                    |                     |
| A-13 Test the Pothole Guard                                      |                                  |                                      |                                    |                     |
| A-14 Inspect Platform Weighing System(optional)                  |                                  |                                      |                                    |                     |
| A-15 Inspect the Raised Limit Function                           |                                  |                                      |                                    |                     |
| A-16 Inspect Platform Lowering Limit                             |                                  |                                      |                                    |                     |
| A-17 Inspect the battery level                                   |                                  |                                      |                                    |                     |

| <b>REPAIR &amp; INSPECTION REPORT</b>                    |                                  |                                      |                                    |                     |
|--|----------------------------------|--------------------------------------|------------------------------------|---------------------|
| A-18 Perform Maintenance After 30 Days                   |                                  |                                      |                                    |                     |
| <b>Checklist B Procedures</b>                            |                                  |                                      |                                    |                     |
| Items  | YES/Machine is in Good Condition | NO/Machine Has Damage or Malfunction | REPAIRED/Machine Has Been Repaired | Problem Description |
| B-1 Inspect Electric Wires                               |                                  |                                      |                                    |                     |
| B-2 Inspect Rim ,Tire and Fasteners                      |                                  |                                      |                                    |                     |
| B-3 Inspect Battery                                      |                                  |                                      |                                    |                     |
| B-4 Inspect Hydraulic Oil                                |                                  |                                      |                                    |                     |
| B-5 Inspect Hydraulic Oil Tank Ventilation System        |                                  |                                      |                                    |                     |
| B-6 Inspect Brake Manual Release Function                |                                  |                                      |                                    |                     |
| <b>Checklist C Procedures</b>                            |                                  |                                      |                                    |                     |
| Items  | YES/Machine is in Good Condition | NO/Machine Has Damage or Malfunction | REPAIRED/Machine Has Been Repaired | Problem Description |
| C-1 Replace Hydraulic Oil Tank Air Filter                |                                  |                                      |                                    |                     |
| <b>Checklist D Procedures</b>                            |                                  |                                      |                                    |                     |
| Items  | YES/Machine is in Good Condition | NO/Machine Has Damage or Malfunction | REPAIRED/Machine Has Been Repaired | Problem Description |
| D-1 Inspect Scissor Arm Installation Bearing             |                                  |                                      |                                    |                     |
| D-2 Inspect Chassis Slider                               |                                  |                                      |                                    |                     |
| D-3 Replace Hydraulic Oil Tank Return Oil Filter Element |                                  |                                      |                                    |                     |
| D-4 Inspect and Replace Hydraulic Oil                    |                                  |                                      |                                    |                     |
| D-5 Inspect Key Structural Parts                         |                                  |                                      |                                    |                     |
| User   |                                  |                                      |                                    |                     |
| Inspector Signature                                      |                                  |                                      |                                    |                     |
| Inspector Date   |                                  |                                      |                                    |                     |



### REPAIR & INSPECTION REPORT

|                   |  |
|-------------------|--|
| Inspector Title   |  |
| Inspector Company |  |

**NOTES:**

1. The Repair & Inspection Report shall include the inspection table of each regular inspection.
2. Duplicate the Repair & Inspection Report for each inspection. Store the completed tables for 10 years or until the machine is no longer in use or as required by machine owner/company/custodian.
3. Use the table to record the results. After each section is complete, mark the appropriate box.
4. Record the inspection results. If any inspection results are "NO", the machine must be stopped and re-inspected after repair is completed and marked in the box marked "inspection".

Select the appropriate inspection procedure based on the inspection type.

# Always for Better Access Solutions



## Hunan Sinoboom Intelligent Equipment Co., Ltd.

No.128, East Jinzhou Avenue, Ningxiang High-tech Industrial Park, Changsha, Hunan, China

☎ 0086-400-601-5828 (Sales) / 0086-400-608-1289 (Service)

✉ [info@sinoboom.com](mailto:info@sinoboom.com)

🏠 [www.sinoboom.com](http://www.sinoboom.com)

---

### North American Subsidiary

#### Sinoboom North American LLC

310 Mason Creek Drive  
unit #100  
Katy, TX 77450, US  
Tel: (281) 729-5425  
E-mail: [info@sinoboom.us](mailto:info@sinoboom.us)

### Europe Subsidiary

#### Sinoboom B.V.

Nikkelstraat 26, NL-2984 AM Ridderkerk,  
The Netherlands  
Tel: +31 180 225 666  
E-mail: [info@sinoboom.eu](mailto:info@sinoboom.eu)

### Korea Subsidiary

#### Sinoboom Korea Co., Ltd.

95, Docheong-ro, Yeongtong-gu, Suwon-  
si, Gyeonggi-do, Republic of Korea  
Tel: 010-8310-8026  
E-mail: [ka1@sinoboom.com](mailto:ka1@sinoboom.com)

### Australia Subsidiary

#### Sinoboom Intelligent Equipment Pty Ltd.

112 Robinson Road #03-01 Robinson 112  
Singapore 068902

### Singapore Subsidiary

#### Star Access Solutions Pte. Ltd.

50/358 Clarendon St, South Melbourne  
VIC 3205, Australia  
E-mail: [au@sinoboom.com](mailto:au@sinoboom.com)